



Distributed by:

**Lab Unlimited**  
CARL STUART GROUP

Tallaght Business Park  
Whitestown, Dublin 24,  
Ireland  
D24 RFK3

Tel: (01) 4523432  
Fax: (01) 4523967  
E-mail: [info@labunlimited.com](mailto:info@labunlimited.com)  
Web: [www.labunlimited.com](http://www.labunlimited.com)

Quatro House, Frimley Road,  
Camberley,  
United Kingdom  
GU16 7ER

Tel: 08452 30 40 30  
Fax: 08452 30 50 30  
E-mail: [info@labunlimited.co.uk](mailto:info@labunlimited.co.uk)  
Web: [www.labunlimited.co.uk](http://www.labunlimited.co.uk)

---

## Operating Instructions for Quick Drying Machine Type TG200

**Retsch**<sup>®</sup>

---

# Preliminary notes on these operating instructions

These operating instructions for the Quick Drying Machine, type TG 200, give all the necessary information for the areas mentioned in the contents.

The instructions given here are aimed at the target group(s) defined for each area, in order to ensure safe handling of the TG200 and its use for the intended purpose. A knowledge of the relevant section in the instructions is the prerequisite for safe handling and use for the intended purpose by the particular target group(s).

This technical documentation is a reference work and contains learning instructions. The individual sections are complete in themselves.

These operating instructions do not include instructions for repairs. If repairs are necessary please contact your supplier or Retsch GmbH directly.

## Warning instructions

Warnings are indicated with the following signs:



**Injury to persons or  
Damage to the machine**



**Follow the operating instructions**

## Repairs

These operating instructions do not include instructions for repairs. For your own safety repairs should be carried out only by Retsch GmbH, an authorised agent or service technicians.

### In this case please inform:

the Retsch agent in your country
your supplier
Retsch GmbH directly

### Your service address is as follows:

<b>Preliminary notes on these operating instructions</b> .....	<b>2</b>
Warning instructions .....	2
Repairs .....	2
<b>Safety</b> .....	<b>4</b>
Safety instructions.....	4
Safety instructions, summary, part 1 .....	5
Safety regulations, summary, part 2.....	6
<b>Confirmation</b> .....	<b>7</b>
<b>Technical data</b> .....	<b>8</b>
Use according to the intended purpose.....	8
Emission .....	9
Heating power .....	9
Fan power .....	9
Rated power .....	9
Systems of protection .....	9
Machine dimensions.....	9
Required floor space .....	9
<b>Transport and installation</b> .....	<b>10</b>
Packing material.....	10
Transport .....	10
Temperature variations .....	10
Intermediate storage .....	10
Parameters for the place of installation .....	11
Installation .....	11
Electrical connection .....	11
<b>Operation</b> .....	<b>12</b>
Operating elements and operation.....	12
Operating the TG200 .....	13
Switching on / off .....	13
Starting – interruption - stopping .....	13
Setting the time .....	14
Setting the heating power temp °C/°F .....	14
Triggering the bimetallic element switch in the heater... ..	15
Setting the air flow .....	15
Interval – continuous operation.....	15
Drying mode.....	16
Storage and recalling drying parameters .....	16
Signal tone for end of drying process .....	16
<b>Inserting the drying vessels</b> .....	<b>17</b>
6 litre drying vessels of glass or stainless steel .....	17
Verwendung der weichenen Dichtung im Spanndeckel ..	17
Use and installation of the 63µm disk as additional filter	17
Inserting the clamping lid with filter element .....	18
Attachment with 3 x 300 ml glass vessels.....	18
<b>Working instructions</b> .....	<b>19</b>
General .....	19
Mode of operation of the TG200 .....	19
Attainable temperatures at the measuring point.....	20
Operating conditions 1:.....	20
Operating conditions 2: .....	20
Operating conditions 3:.....	20
<b>General</b> .....	<b>21</b>
Cleaning.....	21
Maintenance .....	21
Replacing fuses .....	22
Accessories.....	22
Wearing parts .....	23
Fault codes .....	23
Copyright .....	23
Alterations.....	23
<b>Appendix</b> .....	<b>following pages</b>

# Safety

The TG200 is an ultra-modern, highly efficient product from Retsch GmbH, and corresponds to state-of-the-art technology. When using the machine according to the intended purpose and with a knowledge of the technical documentation described here it is completely reliable and safe to operate.

## Safety instructions

As the operating authority you must ensure that all persons authorised to work on the TG 200:

- are aware of, and have understood all the safety regulations,
- are aware of all the handling instructions and regulations for the target group of relevance to them before starting work,
- have access to the technical documentation for this machine at all times without problems.
- Before beginning work on the TG200 new personnel must have been made familiar with safe handling of the machine and its operation according to the intended purpose, either by verbal instruction from a competent person and/or through reading this technical documentation.
- Improper operation can cause injury to persons and damage to the machine. You are responsible for your own safety and that of your employees.
- Make sure that no unauthorised persons have access to the TG200.

For your own protection have knowledge of the instructions for operating the TG200 confirmed by your employees. A draft of a suitable form is given on the page following the section on safety.



We exclude any liability for claims for damages in any form whatsoever for injury to persons or damage to the machine caused through non-observance of the following safety instructions.

# Safety instructions, summary, part 1

## Safety instructions



We exclude any liability for claims for damages in any form whatsoever for injury to persons or damage to the machine caused through non-observance of the following safety instructions.

## Use according to the intended purpose



Do not make any alterations to the machine and use only spare parts and accessories approved by Retsch. **Otherwise the Declaration of Conformity with European directives made by Retsch will lose its validity. Furthermore this will also lead to the loss of any guarantee claims.**



Do not dry explosives or easily flammable materials, or materials with a flashpoint below 180°C in the TG200. **Risk of fire and explosion.**



Do not operate the TG200 in the vicinity of easily flammable materials. **Risk of fire and explosion.**



You must check to what extent toxic danger exists through the charged material. **Risk to health through vapours or residual dusts which are not retained by the filters.**



Do not operate the TG200 without supervision. **Risk of fire and explosion.**



Materials should be dried only in the appropriate time, at the appropriate temperature. Take into consideration the melting point and temperature sensitivity of the material. **The material to be dried can be destroyed through overheating.**

## Packing materials



Please keep the packing material for the duration of the guarantee period, since, in case of a complaint and return of the machine in unsuitable packing material your guarantee claim will be at risk.

## Transport



The TG200 must not be jolted, shaken or thrown during transport. Otherwise the electronic and mechanical components may be damaged.

## Temperature variations



If subjected to high temperature variations (e.g. during transport by aircraft) the TG200 must be protected against condensed water. Otherwise the electronic components may be damaged.

## Supply schedule



If the delivery is incomplete and/or transport damaged is found, you must inform the transporter and Retsch GmbH immediately (within 24 hrs). Later complaints may possibly be no longer considered.

## Ambient temperature:



If the temperature drops below, or exceeds the ambient temperature the electrical and mechanical components may be damaged; the performance data are then altered to an unknown extent.

## Atmospheric humidity:



At high atmospheric humidity the electrical and mechanical components may be damaged and the performance data are altered to an unknown extent.

## Installation



Maintain a safety distance of 100 mm all round. The hot air outlet can ignite easily flammable objects. **Risk of fire and explosion.**

## Electrical connection / connecting the power supply



If the values on the rating plate are not observed the electrical and mechanical components may be damaged.

## Safety regulations, summary, part 2



### Setting the heating power – temp °C/°F

Do not dry explosives, easily flammable materials or materials with a flashpoint below 180°C in the TG200.  
**Risk of fire and explosion.**

Do not operate the TG200 in the vicinity of easily flammable materials.  
**Risk of fire and explosion.**

You must check to what extent toxic danger exists through the charged material.  
**Risk to health through vapours or residual dusts which are not retained by the filters.**

### Triggering the bimetallic element switch in the heater, automatic switch off when overheated



The bimetallic element switch is triggered when a temperature > 150°C/302°F has been reached. This can result from too low fan power and at the same time too high stagnation pressure caused by the material to be dried. Before restarting the machine the temperature should be reduced by 5 – 10°C.  
**Otherwise the heater may be damaged.**

### Inserting the drying vessels



We recommend that protective gloves are worn when removing the vessels and the clamping lid at the end of the drying process.  
**Risk of burns.**

### Inserting the clamping lid with filter element



We recommend that protective gloves are worn when removing the vessels and clamping lid at the end of the drying process.  
**Risk of burns.**

When using the clamping lid with filter element the TG200 may be operated only up to a temperature of max. +90°C/+194°F.  
**Otherwise the filter fabric will burn. Risk of fire.**

### Cleaning / maintenance



Do not clean the **TG200** under running water.  
**Danger to life through current surge.**

If the filter element and filter bags are contaminated too much the efficiency of the TG200 will be reduced to an unknown extent.

### Wearing parts



These operating instructions do not include any repair instructions. For your own safety repairs should be carried out only by Retsch GmbH, an authorised agent or service technician.

## Confirmation

I have noted the sections on Notes on Operating Instructions and safety.

---

Signature of operator

---

Signature of service technician







# Technical data

Machine type designation: **TG200**

## Use according to the intended purpose

Depending on the specific properties of the material to be dried, materials with a moisture content of max. approx. 80% can be dried. The size of the batch is normally 1000 ml. In some cases, e.g. with lightweight, high volume materials, the complete vessel volume can be utilized. The minimum grain size should not be less than 63 µm.

The TG200 is not designed as a production machine or for continuous operation but as a laboratory machine, intended for one shift operation of 8 hours.

	<p>Do not make any alterations to the machine and use only spare parts and accessories approved by Retsch.</p> <p><b>Otherwise the Declaration of Conformity with European directives made by Retsch will lose its validity.</b></p> <p><b>Furthermore this will also lead to the loss of any guarantee claims.</b></p>
	<p>Do not dry explosives, easily flammable materials or materials with a flashpoint below 180°C in the TG200.</p> <p><b>Risk of fire and explosion.</b></p>
	<p>Do not operate the TG200 in the vicinity of easily flammable materials.</p> <p><b>Risk of fire and explosion</b></p>
	<p>You must check to what extent toxic danger exists through the charged material.</p> <p><b>Risk to health through vapours or residual dusts which are not retained by the filters.</b></p>
	<p>Do not operate the TG200 without supervision.</p> <p><b>Risk of fire and explosion.</b></p>
	<p>Materials should be dried only in the appropriate time, at the appropriate temperature. Take into consideration the melting point and temperature sensitivity of the material.</p> <p><b>The material to be dried can be destroyed through overheating.</b></p>





## Emission

### Noise characteristic values :

Noise measurement according to DIN 45635-031-01-KL3  
The noise characteristic values depend on the set fan power and the type of material to be dried.

#### Example:

Acoustic power level  $L_{WA} = 88 \text{ dB(A)}$

Emission value related to working area  $L_{pAeq} = 75 \text{ dB(A)}$

#### Operating conditions:

Material to be dried = clay, filling level 225 mm

Max. heating power, max. fan power

## Heating power

The heating power depends on the type and quantity of material to be dried and the set fan power.

The nominal value is  $2 \times 1000 \text{ W}$ .

Basic heating takes place through the power output of the radial fan, depending on the air flow.

## Fan power

The fan power depends on the type and quantity of the material to be dried and the accessories used.

The value is approx.  $185 \text{ m}^3/\text{hr}$  at no-load operation without material to be dried.

## Rated power

At:

240V = 2990 VA

230V = 2865 VA

220V = 2740 VA

200V = 2490 VA

## Systems of protection

IP43 or

IP20 without drying vessel and lid in position

## Machine dimensions

Height: approx. 1000 mm, width: 400 mm, depth: 480 mm

Weight: approx. 21 kg without drying vessel

## Required floor space

Width 400 mm x depth 540 mm

Safety distance of 100 mm from the rear panel is necessary.

# Transport and installation

## Packing material

The packing material is adapted to the transport route and conforms to generally applicable packing directives.



Please keep the packing material for the duration of the guarantee period, since, in case of a complaint and return of the machine in unsuitable packing material your guarantee will be at risk.

## Transport



The TG200 must not be jolted, shaken or thrown during transport. Otherwise the electronic and mechanical components may be damaged.

## Temperature variations



If subjected to high temperature variations (e.g. during transport by aircraft) the TG200 must be protected against condensed water. Otherwise the electronic components may be damaged.

## Intermediate storage

Make sure that the TG200 is also kept dry during intermediate storage.

## Parameters for the place of installation

### **Ambient temperature:**

5°C to 40°C



If the temperature drops below or exceeds the ambient temperature the electrical and mechanical components may be damaged. The performance data are altered to an unknown extent.

### **Atmospheric humidity:**

Maximum relative humidity 80% at temperatures up to 31°C, linear decrease up to 50% relative humidity at 40°C.



At high atmospheric humidity the electrical and mechanical components may be damaged. The performance data are altered to an unknown extent.

### **Installation height:**

Max. 2000 m above sea level.

## Installation

Install the TG200 only on a robust laboratory bench.



Maintain a safety distance of 100 mm all round.

The hot air outlet can ignite easily flammable objects.

**Risk of fire and explosion.**

## Electrical connection

- The voltage and frequency of the TG200 is given on the rating plate.
- Ensure that the values agree with the existing mains supply.
- Connect the TG200 to the mains supply using the connection cable supplied with the machine.
- An external fuse of min. 20A should be installed when connecting the power supply cable to the mains, in accordance with the regulations at the place of installation.

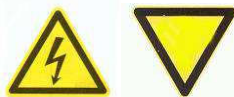

If the values on the rating plate are not observed the electrical and mechanical components may be damaged.

# Operation

## Operating elements and operation

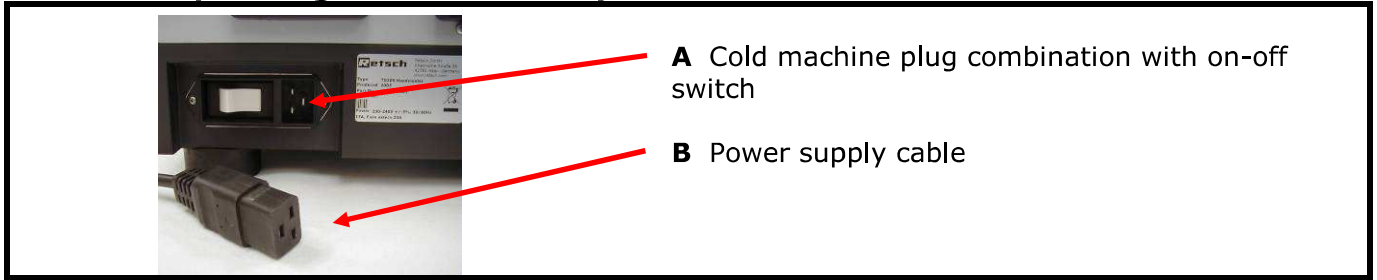

**A** Cold machine plug combination with on-off switch

**B** Power supply cable



<b>1</b>	Key for recalling preselected drying parameters <b>P1-P9</b> and <b>on</b>
<b>2</b>	The selected programme <b>P1-P9</b> / <b>on</b> is displayed here.
<b>3</b>	Key for activating the setting mode for the preselected programme locations <b>P1-P9</b>
<b>4</b>	This key reduces the temperature <b>000-150°C</b> or <b>032-302°F</b> For switching over from °C to °F or vice-versa press keys " <b>4+6</b> " simultaneously.
<b>5</b>	Display shows preselected temperature and, after starting the TG200, the actual measured temperature.
<b>6</b>	This key increases the temperature <b>000-150°C</b> or <b>032-302°F</b> For switching over from °C to °F or vice-versa press keys " <b>4+6</b> " simultaneously.
<b>7</b>	This key reduces the fan power, <b>99 – 10</b>
<b>8</b>	Display shows preselected fan power <b>10 – 99</b>
<b>9</b>	This key increases the fan power, <b>10 – 99</b>
<b>10</b>	This key switches <b>ON</b> interval operation, left LED lights up. 10 sec pause-10 sec operation
<b>11</b>	This key switches <b>OFF</b> interval operation, right LED lights up
<b>12</b>	This key reduces the drying period, <b>99 – 01min.</b> or - - continuous operation
<b>13</b>	Display shows the preselected drying period <b>01 – 99min.</b> or - - continuous operation
<b>14</b>	This key increases the drying period, <b>01 – 99min.</b> or - - continuous operation
<b>15</b>	<b>START</b> key, starts the drying process and the green LED lights up Press <b>START</b> key twice for quick start with max. heating power + max. fan power; green LED lights up.
<b>16</b>	1x <b>STOP</b> key, heater is switched off Red LED over key <b>16</b> flashes 2x <b>STOP</b> key, stops and ends the drying process and the red LED lights up.

## Operating the TG200

### Switching on / off



E

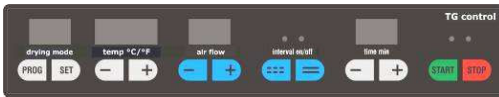

The main switch **E** is located on the right hand side of the rear panel of the **TG200**

- Switch on the main switch
- **ON** lights up in the display **drying mode**
- **000** lights up in the display **temp °C/°F**
- **10** lights up in the display **air flow**
- LED **interval off** lights up
- Two dashes (==) light up in the display **time**
- The values appear at the first start. If the values are changed they are retained at the end of the programme and appear when switching on again and pressing the **START** key.

The TG200 is now ready for operation, without interval, for continuous operation without heating and with minimum fan power.

### Starting – interruption - stopping

#### Starting:

Press **START** / key **15**

- Green LED over key **15** lights up
- TG200 starts with specified values.
- Red LED over key **16a** flashes as long as a temperature has not been specified.
- Specify temperature, red LED is extinguished, green LED lights up.

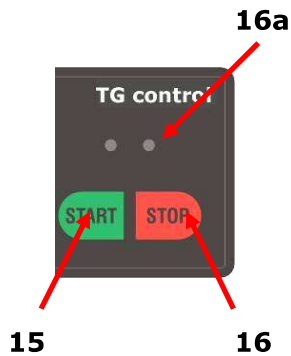

During the drying period the temperature is kept constant within a tolerance. This means that the heater is switched off when the specified temperature has been reached and is switched on again when the temperature drops below the specified value. A temperature difference of +/- 2°C or +/-50°F is possible here.

#### Quick start with full power:

Press **START** / key **15** twice

- Green LED over key **15** lights up
- TG200 starts with full heating power and fan power for an indefinite running period
- The measured temperature is displayed



#### Stopping:

- Press **STOP** / key **16** – heater is switched off
- Red LED over key **16** flashes
- Press **STOP** / key **16** a second time – everything is switched off
- Red LED over key **16** lights up
- The complete display except **on** is extinguished
- Activate LED displays = press key **15** once
- New values can be entered
- Press **START** / key **15** a second time
- Function is carried out as with **Starting**



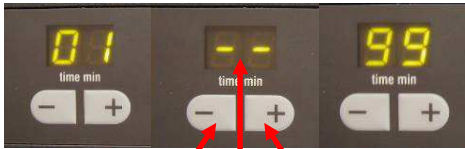

12 13 14



4 5 6



## Setting the time

When the **TG200** is switched on the drying period is still indefinite = 2 dashes in display **13**.

### Switch on time 1 – 99 min. or - - continuous operation:

- Key **12** reduces the time down to 1 min. If the time drops below this value two dashes appear = indefinite time
- Key **14** increases the time up to 99 min. If this time is exceeded two dashes appear = indefinite time

## Setting the heating power temp °C/°F

When the **TG200** is switched on the heater is switched off.

**000°C/032°F** is shown in the display **5**.

This is indicated by flashing of the red LED over the STOP key. The temperature is measured in °C or °F and shown in the display **5**.

The temperature display can be changed over from centigrade to Fahrenheit with keys **4+6**. Not during the performance possibly.

- Press keys **4+6** simultaneously
- An **F** for Fahrenheit appears briefly in the display **5**
- Press keys **4+6** simultaneously
- A **C** for centigrade appears briefly in the display **5**

### Switching on the heater 000 – 150°C / 000 – 302°F:

- Key **4** reduces the temperature down to **000°C/032°F**.
- Temperature **000°C/032°F** = heater is switched off, red LED over START flashes.
- Key **6** increases the temperature to **150°C/302°F**.

As soon as the temperature is increased with key **6** the heater switches on, the red LED over STOP is extinguished and the green LED lights up. The attainable heating power depends on the material to be dried, the filling quantity and the fan power **air flow**. This can only be determined empirically.



Do not dry explosives, easily flammable materials or materials with a flashpoint below 180°C in the TG200.

**Risk of fire and explosion.**

Do not operate the TG200 in the vicinity of easily flammable materials.

**Risk of fire and explosion.**

You must check to what extent toxic danger exists through the charged material.

**Risk to health through vapours or residual dusts which are not retained by the filters.**

## Triggering the bimetallic element switch in the heater

The heater is fitted with a bimetallic element switch. If a fault occurs this switches off the heater at 160°C/320°F +/- 6%. The fan power is immediately set to maximum and the heater switched off.

After a cooling cycle has taken place the TG200 must be restarted.



2 5 8 16

- Display 2 shows fault code **F2**
- Temperature is reduced, display **5**
- Fan power is set to max. **99**, display **8**
- **Red** LED over STOP key **16** lights up

The cooling cycle is started.



The bimetallic element switch is triggered when a temperature > 150°C/302°F has been reached. This can result from too low fan power and at the same time too high stagnation pressure caused by the material to be dried. Before restarting the machine the temperature should be reduced by 5 – 10°C.

**Otherwise the heater may be damaged.**

## Setting the air flow

### Reducing:

- Key **12** reduces the fan power down to the minimum power step, **10** is indicated in display **13**.
- Keep key **12** pressed; after 5 sec. quicker adjustment is possible

### Increasing:

- Key **14** increases the fan power up to the maximum power step, **99** is indicated in display **13**.
  - Keep key **14** pressed; after 5 sec. quicker adjustment is possible
- It is not possible for the value to drop below **10** or to exceed **99**.

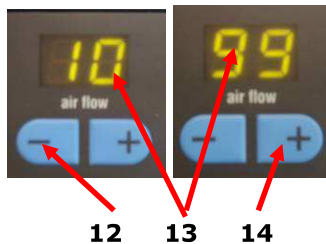

## Interval – continuous operation

At the time of switching on the **TG200** interval operation is switched off. Not during the performance possibly. When Interval is switched on the air flow can no longer be changed.

### Switching on interval:

- Press key **10**
- LED over key **10** lights up
- Pause for 10 sec with fan switched off; heater is switched off
- Operation for 10 sec with reselected fan power; heater is switched on again

### Switching off interval:

- Press key **11**
- LED over key **11** lights up

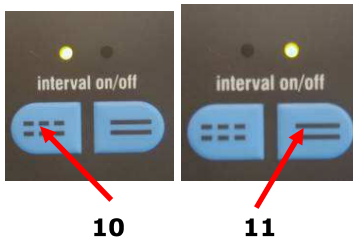

## Drying mode Storage and recalling drying parameters

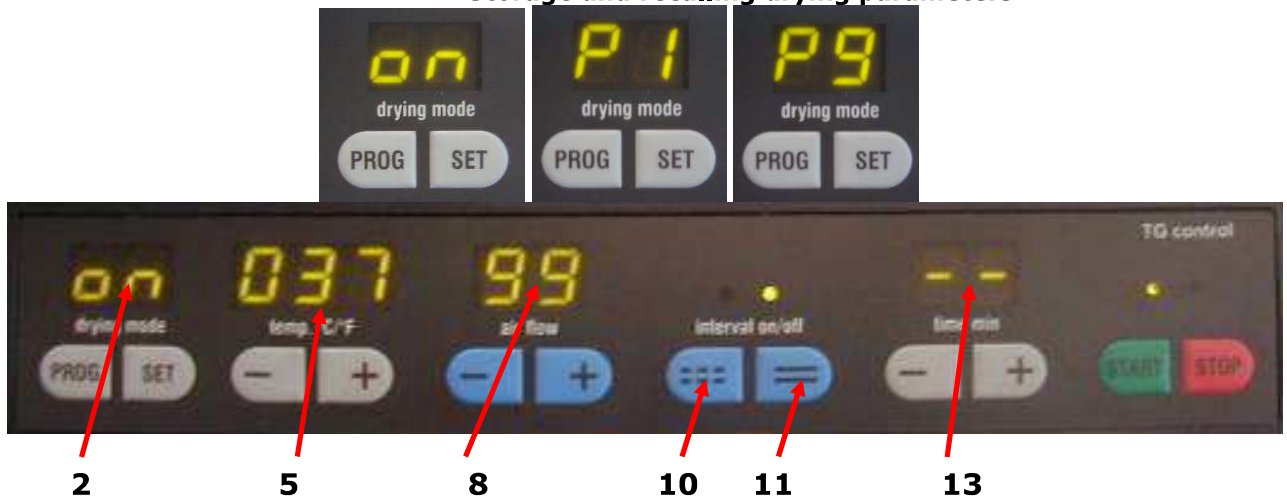

You can store, change or overwrite the drying parameters **temp – air flow – interval and time** at any time in the programme positions **P1 to P9**.

After switching on the **TG200** the indication **"on"** appears in the display **2**.

By pressing the key **PROG** the next programme position **P1 to P9** can be reached. After programme position **P9 on** reappears in the display. In the **PROG** mode all keys except **PROG, START and STOP** are inhibited.

- **on** = free adjustment of the drying parameters **5/8/10-11** and **13** is possible, or
- **P1 to P9** = parameters can be saved and recalled here
- **Start** = drying process is started with the parameters stored in programme position **P1 to P9**.

### Allocation of storage location

- Press **PROG** key until required storage location **P1-P9** has been reached.
- Press **SET** key – all displays flash
- Set drying parameters **5/8/10-11/13**
- Press **SET** key; values are stored

Flashing of the display stops, the adjustment inhibitor is activated and sieve parameters are stored. In the **PROG** mode all keys except **PROG, START and STOP** are inhibited.

### Signal tone for end of drying process

If the drying process is brought to an end within a definite time without interruption, the end is signalled by an acoustic signal tone which is sounded 5 times.



## Inserting the drying vessels

### 6 litre drying vessels of glass or stainless steel

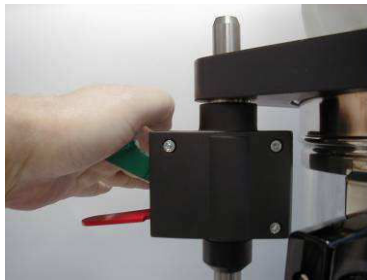
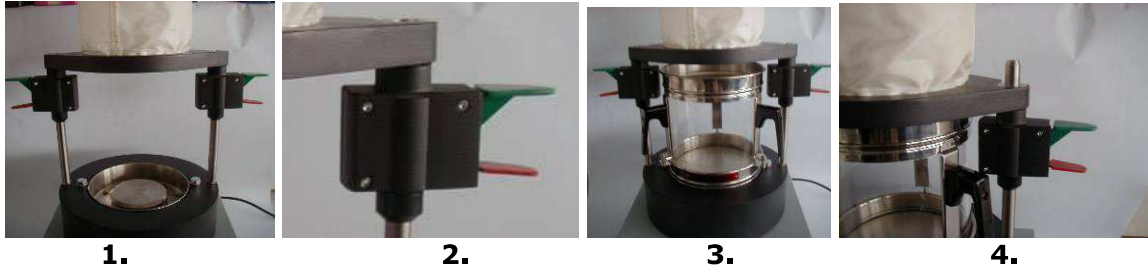

5.

The drying vessels of 6 litres capacity are not included in the items supplied with the **TG200**. They are available as separate accessories.

Art. No. 72.783.0001 – glass vessel

Art. No. 72.783.0002 - vessel of stainless steel

1. Place clamping lid in position, in doing so press the red lever upwards – the clamping lid can now be moved
2. fits with the top edge of the support rod
3. Fill material to be dried. Place vessel in position
4. Tighten clamping lid
5. Press green lever downwards several times



We recommend that protective gloves are worn when removing the vessel and the clamping lid after the drying process.

**Risk of burns.**

### Verwendung der weicheren Dichtung im Spanndeckel

Bei sehr feinen staubigen Materialien kann die weichere im Lieferumfang enthaltene Dichtung eingesetzt werden.

Dichtung **D** im Deckel entnehmen und durch die weichere Dichtung **W** ersetzen.

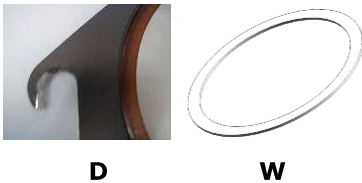

D

W

### Use and installation of the 63µm disk as additional filter



6.

7.

8.

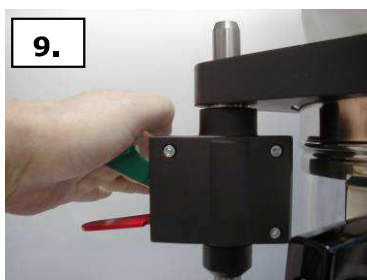

9.

The disk are not included in the items supplied with the **TG200**. They are available as separate accessories.

Art. No 03.648.0009 – sieve bottom Trapezoid 63 µm

6. Remove clamping elements and seal
7. Insert sieve bottom, Trapezoid 63 µm, centrally
8. Replace seal
9. Insert clamping elements and clamping lid. In doing so press the green lever downwards several times.

## Inserting the clamping lid with filter element

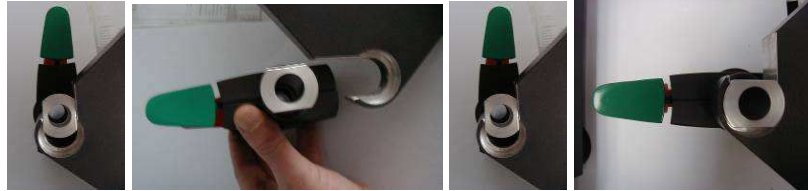

10.

11.

12.

13.



14.

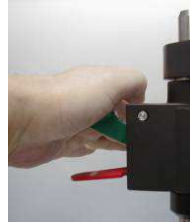

15.

The quick clamping lid with replaceable filter element is not included in the items supplied with the **TG200**. It is available as a separate accessory.

Art. No 72.643.0001 – quick clamping lid with replaceable filter element

10. Turn clamping elements backwards
11. Remove clamping elements
12. Insert clamping elements in the quick clamping lid
13. Turn clamping elements to locking position
14. Place quick clamping lid with clamping elements in position and tighten
15. Press green lever downwards several times



We recommend that protective gloves are worn when removing the vessel and clamping lid at the end of the drying process.

### Risk of burns.

When using the clamping lid with filter element the TG200 may be operated only up to a temperature of max. +90°C/+194°F.

**Otherwise the filter fabric will burn. Risk of burns.**

## Attachment with 3 x 300 ml glass vessels



16.



17.



18.



19.

The glass drying vessels, of 3 x 300 ml capacity, are not included in the items supplied with the TG200. They are available as a separate accessory.

Art. No 72.002.0005 – glass vessels 3x 300ml



20.



21.

16. Insert intermediate ring
17. Place clamping lid in position
18. Position clamping elements and tighten
19. Press green lever downwards several times
20. Fill glass vessels and place in position
21. Clamp tightly by turning clockwise



We recommend that protective gloves are worn when removing the vessel and clamping lid after the drying process.

### Risk of burns.



When using the lid with filter element the TG200 may be operated only up to a temperature of max. +90°C/+194°F.

**Otherwise the filter fabric will burn. Risk of fire.**

# Working instructions

## General

The TG200 is an ultra-modern, highly efficient product from the firm Retsch GmbH. Through the fluidized bed technology (see schematic diagram) and the generously dimensioned drying vessels materials can be dried effectively in the TG200 within a few minutes. The air throughput and heating power can be set separately, the temperature reached depending on the air throughput and the material to be dried. In this process agglomeration, as with conventional drying processes, is avoided to a considerable extent; further processing is thus facilitated.

A large selection of accessories makes it possible to use the machine for many different applications (see section on accessories).

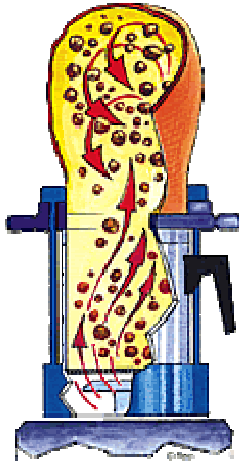

**Schematic diagram**

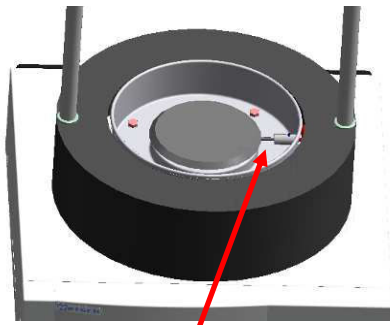

**TM**

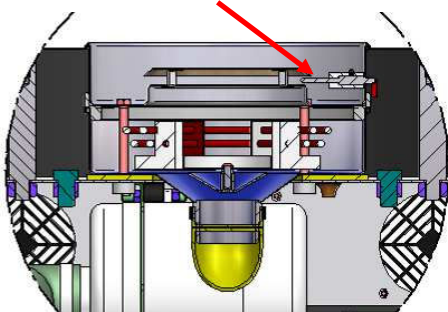

## Mode of operation of the TG200

Air filtered on the suction side (filter quality – pore size 30 µm) is passed through a radial fan into the heating chamber. The heated air then enters the drying vessel and brings about continuous circulation of the material to be dried through the fluidized bed technology in the drying vessel.

See **schematic diagram**.

The hot air removes moisture from the material to be dried and escapes through the filter bag or filter element (30 µm pore size).

The temperature is measured below the drying vessel in the air stream.

See photo – temperature measuring point **TM**.

On completion of the drying process the vessel with dried material can be easily removed.

When removing the lid and drying vessel hold this only by the plastic grips or clamping elements provided. We recommend the use of protective gloves.

**Risk of burns on hot metal and glass components.**

## Attainable temperatures at the measuring point

Since the attainable temperature depends on the set fan power, the charged material to be dried and the type of clamping lid, the table below serves as a guide. The temperature in the TG200 is measured at the measuring point **TM**.

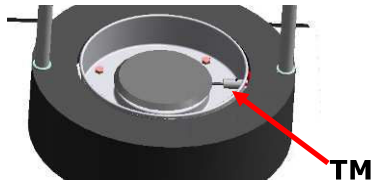

Max. temperature set at 150°C or 302°F

Ambient temperature of 23°C / 73.4°F

Time 8 min

Air flow	Attainable temp °C (±10%)	Attainable temp °F (±10%)
99	ca. 87°C	ca. 188°F
60	ca. 93°C	ca. 199°F
40	ca. 100°C	ca. 212°F
20	ca. 128°C	ca. 262°F
10	ca. 150°C	ca. 302°F

### Operating conditions 2:

TG200 without material to be dried and with attachment with 3 glass vessels, each of 0.3 ltr, as separate accessory - Art. No. 72.002.0005



Max. temperature set at 150°C or 302°F

Ambient temperature of 23°C / 73.4°F

Time 8 min

Air flow	Attainable temp °C (±10%)	Attainable temp °F (±10%)
99	ca. 108°C	ca. 226°F
60	ca. 115°C	ca. 239°F
40	ca. 124°C	ca. 255°F
20	ca. 150°C	ca. 302°F

### Operating conditions 3:

TG200 without material to be dried and with as separate accessory - Art. No. 72.643.0001



Max. temperature set at 150°C or 302°F

Ambient temperature of 23°C / 73.4°F

Time 8 min

Air flow	Attainable temp °C (±10%)	Attainable temp °F (±10%)
99	ca. 88°C	ca. 190°F
40	ca. 98°C	ca. 208°F
30	ca. 106°C	ca. 222°F
20	ca. 120°C	ca. 248°F
10	ca. 150°C	ca. 302°F

# General

## Cleaning

### TG200

The TG200 should be cleaned only with brushes, and possibly with an industrial vacuum cleaner or with compressed air.

The system of protection for the TG200 with drying vessel and clamping lid is IP43.

Without vessel and lid this is reduced to IP22.



Do not clean the TG200 with running water.  
**Danger to life through current surge.**

### Filter bags

The filter bags can be washed out under running water.

### Filter elements and filter on the machine rear side

These must be replaced when contaminated.

### Drying vessels 6 and 0.3 litres

These can be cleaned under running water or in an ultrasonic bath.



**F1**

## Maintenance

The 3 filters **F1** on the rear side of the machine must be replaced after approx. **100 hrs.** The maintenance interval is shortened depending on the dustiness of the surroundings. This must be assessed empirically by the operator.



If the filter elements and bags are contaminated too much the efficiency of the TG200 will be reduced to an unknown extent.

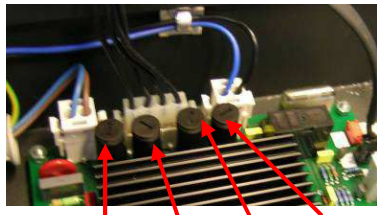
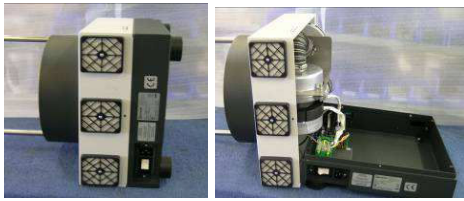
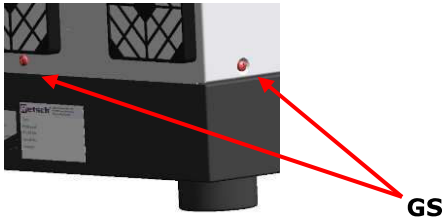

**F3 F4 F2 F1**

## Replacing fuses

- Disconnect mains plug
- Remove 5 housing screws **GS**
- Place upper part of housing carefully on its side
- Remove fuse holders 1 - 4
- Check fuses and replace if necessary
- Fuse F1 = T 10 A (dia. 5x20) for fan
- Fuse F2 = T 10 A (dia. 5x20) for fan
- Fuse F3 = M 10 A (dia. 5x20) for heater
- Fuse F4 = M 10 A (dia. 5x20) for heater

## Accessories



Glass drying vessel, 6 litre  
Art. No. 72.783.0001



Drying vessel of stainless steel, 6 litre  
Art. No. 72.783.0002

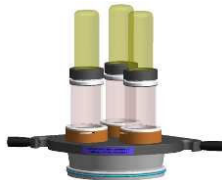

Glass drying vessel, 3 x 0.3 litre

Art. No. 72.002.0005

Spare glass drying vessel, 0.3 litre

Art. No. 02.045.0020

Spare filter bag for glass drying vessel, 0.3 litre

Art. No. 02.186.0004



Lid with filter element for 72.002.0005

Art. No. 72.107.0001

1 spare filter element

Art. No. 03.186.0024



Quick clamping lid with filter element, incl. 10 spare filters

Art. No. 72.643.0001

10 spare filters for 72.643.0001

Art. No. 72.143.0001



Quick clamping lid with filter bag

Art. No. 72.107.0002

Spare filter bag with steel ring

Art. No. 02.186.0015

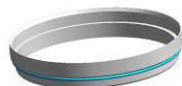

Adaptor for sieve drying for Retsch analytical sieves 8"/203 mm

Art. No. 72.001.0005

## Wearing parts



10 filter mats  
Art. No. 72.143.0003



Vulkollan seal in quick clamping lid  
Art. No. 05.111.0077



O-Ring on steel or glass vessel 185x4  
Art. No. 05.114.0044



These operating instructions do not include instructions for repairs. For your own safety repairs should be carried out only by Retsch GmbH, an authorised agent or service technicians.

## Fault codes



F1  
PT100 temperature sensor is defective or not connected.

Connect or replace the temperature sensor.



F2  
Overload temperature  
Bimetal monitor on the heating tripped.

Reduce the set temperature at the TG200 by at least 5°C.

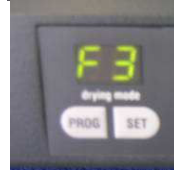

F3  
Fault in blower  
Blower has stopped or the speed is too low.

Increase the speed by at least 5 or replace blower.

## Copyright

Passing on or duplication of this documentation, or use and passing on of the contents, is allowed only with the express permission of Retsch GmbH.  
Persons infringing are liable to pay damages.

## Alterations

Technical data subject to change without notice.





# Rapid Dryer

## TG 200

**Certificate of CE-Conformity according to:**

**EC Mechanical Engineering Directive 2006/42/EC**

Applied harmonized standards, in particular:  
DIN EN ISO 12100      Security of machines

**EC Directive Electromagnetic Compatibility 2004/108/EC**

Applied standards, in particular:

EN 61236      Electrical equipment for measurement, control and laboratory use in  
conjunction with EN 55011 and EN 61000

**Additional applied standards, in particular**

DIN EN 61010      Safety prescriptions concerning measuring-, operating-, controlling- and  
laboratory equipment

**Authorized person for the compilation of technical documents:**

J. Bunke (technical documentation)

**The following records are held by Retsch GmbH in the form of Technical Documentation:**

Detailed records of engineering development, construction plans, study (analysis) of the measures required for conformity assurance, analysis of the residual risks involved and operating instructions in due form according to the approved regulations for preparation of user information data.

The CE-conformity of the Retsch Rapid Dryer Type TG 200 is assured herewith.

**In case of a modification to the machine not previously agreed with us as well as the use of not licensed spare parts and accessories this certificate will lose its validity.**

Retsch GmbH

Haan, January 2010

Dr. Stefan Mähler  
Manager technical services







# **R**etsch

Distributed by:

**Lab Unlimited**  
CARL STUART GROUP

Tallaght Business Park  
Whitestown, Dublin 24,  
Ireland  
D24 RFK3

Tel: (01) 4523432

Fax: (01) 4523967

E-mail: [info@labunlimited.com](mailto:info@labunlimited.com)

Web: [www.labunlimited.com](http://www.labunlimited.com)

Quatro House, Frimley Road,  
Camberley,  
United Kingdom  
GU16 7ER

Tel: 08452 30 40 30

Fax: 08452 30 50 30

E-mail: [info@labunlimited.co.uk](mailto:info@labunlimited.co.uk)

Web: [www.labunlimited.co.uk](http://www.labunlimited.co.uk)