

***cobalt* uv disinfection**

Installation, Operation and Maintenance

# Owner's Manual



SC-200, SC-320, SC-600, SC-740,  
SCM-200, SCM-320, SCM-600, SCM-740

Manufactured in Canada by:



425 Clair Road West • P.O. Box 1719  
Guelph, ON • N1L 1R1 • Canada  
t. 519.763.1032 • f. 519.763.5069  
e. [water@r-can.com](mailto:water@r-can.com)  
i. [www.r-can.com](http://www.r-can.com)

Distributed by:



**Carl Stuart Limited**

ADVANCED APPLIED TECHNOLOGIES

Contact Us:

Int'l Ph: 01 4523432

UK Ph: 08452 30 40 30

Web: [www.carlstuart.com](http://www.carlstuart.com)

Email: [info@carlstuart.com](mailto:info@carlstuart.com)



EPA# 57987-CN-001

April 2006

P/N 520110

*Congratulations,* you have just purchased the new Sterilight® Cobalt™ UV disinfection system. By purchasing this device, you have taken the first step in ensuring the safety of your water supply by using a totally non-intrusive, physical disinfection method. Your Sterilight system uses the most advanced UV technology on the market and is designed to provide you with years of trouble free operation with minimal maintenance required.

**cobalt**

# TABLE OF CONTENTS:

Parts / Schematic Breakdown .....	1
Safety Instructions.....	2
Water Chemistry.....	3
Installing Your UV Disinfection System .....	3-5
Disinfection Procedure.....	6-7
Operating & Maintenance Instructions.....	7-9
Operation .....	10-13
Troubleshooting.....	13-15
Cobalt Series Dose Flow Chart.....	15
Specifications.....	16-17
Manufacturer's Warranty.....	18

## SYMBOLS:



**Caution**

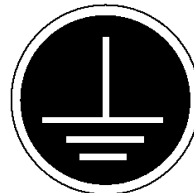

**Protective  
Ground**

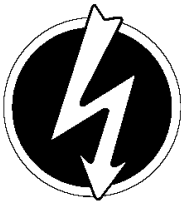

**Electrical  
Warning**



**Fragile**



**Eye Protection**

**PARTS:**

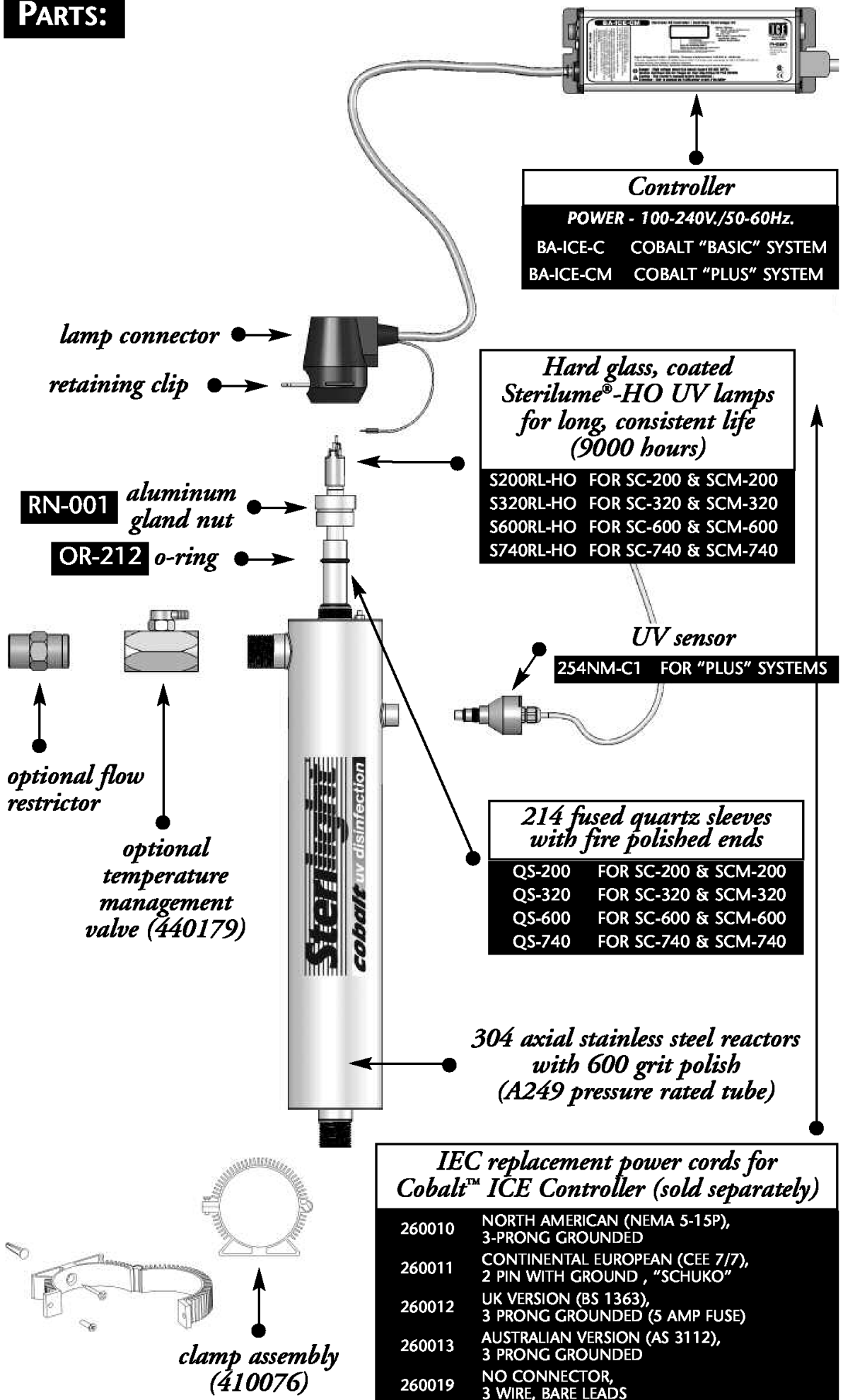

**Controller**  
 POWER - 100-240V./50-60Hz.  
 BA-ICE-C COBALT "BASIC" SYSTEM  
 BA-ICE-CM COBALT "PLUS" SYSTEM

*Hard glass, coated  
 Sterilume®-HO UV lamps  
 for long, consistent life  
 (9000 hours)*

S200RL-HO	FOR SC-200 & SCM-200
S320RL-HO	FOR SC-320 & SCM-320
S600RL-HO	FOR SC-600 & SCM-600
S740RL-HO	FOR SC-740 & SCM-740

**RN-001** aluminum gland nut  
**OR-212** o-ring

optional flow restrictor  
 optional temperature management valve (440179)

UV sensor  
**254NM-C1** FOR "PLUS" SYSTEMS

*214 fused quartz sleeves  
 with fire polished ends*

QS-200	FOR SC-200 & SCM-200
QS-320	FOR SC-320 & SCM-320
QS-600	FOR SC-600 & SCM-600
QS-740	FOR SC-740 & SCM-740

















*304 axial stainless steel reactors  
 with 600 grit polish  
 (A249 pressure rated tube)*

*IEC replacement power cords for  
 Cobalt™ ICE Controller (sold separately)*

260010	NORTH AMERICAN (NEMA 5-15P), 3-PRONG GROUNDED
260011	CONTINENTAL EUROPEAN (CEE 7/7), 2 PIN WITH GROUND, "SCHUKO"
260012	UK VERSION (BS 1363), 3 PRONG GROUNDED (5 AMP FUSE)
260013	AUSTRALIAN VERSION (AS 3112), 3 PRONG GROUNDED
260019	NO CONNECTOR, 3 WIRE, BARE LEADS

clamp assembly  
 (410076)

## SAFETY INSTRUCTIONS:

-  **WARNING** - to guard against injury, basic safety precautions should be observed, including the following:
- 1. READ AND FOLLOW ALL SAFETY INSTRUCTIONS.**
  -  **2. CAUTION** - Disconnect power before servicing.
  -   **3. DANGER** - To avoid possible electric shock, special care should be taken since water is present near electrical equipment. Unless a situation is encountered that is explicitly addressed by the provided maintenance and troubleshooting sections, do not attempt repairs yourself, refer to an authorized service facility.
  -   **4.** Carefully examine the disinfection system after installation. It should not be plugged in if there is water on parts not intended to be wet.
  -   **5.** Do not operate the disinfection system if it has a damaged cord or plug, if it is malfunctioning or if it has been dropped or damaged in any manner.
  -   **6.** Always disconnect water flow and unplug the disinfection system before performing any cleaning or maintenance activities. Never yank the cord to remove from an outlet; grasp the wall plug and pull to disconnect.
  -  **7.** Do not use this disinfection system for other than intended use (potable water applications). The use of attachments not recommended or sold by the manufacturer / distributor may cause an unsafe condition.
  -  **8.** Intended for indoor use only. Do not install this disinfection system where it will be exposed to the weather or to temperatures below freezing. Do not store this disinfection system where it will be exposed to the weather. Do not store this disinfection system where it will be exposed to temperatures below freezing unless all water has been drained from it and the water supply has been disconnected.
  -  **9.** Read and observe all the important notices and warnings on the water disinfection system.
  -   **10.** If an extension cord is necessary, a cord with a proper rating should be used. A cord rated for less Amperes or Watts than the disinfection system rating may overheat. Care should be taken to arrange the cord so that it will not be tripped over or pulled.
  - 11. SAVE THESE INSTRUCTIONS.**
-   **Warning:** The UV light given off by this unit can cause serious burns to unprotected eyes and skin. Never look directly at an illuminated UV lamp. When performing any work on the UV disinfection system always unplug the unit first. Never operate the UV system while the UV lamp is outside of the UV chamber.

**Note:** The UV lamp inside of the disinfection system is rated at an effective life of approximately 9000 hours. To ensure continuous protection, replace the UV lamp annually.

## WATER CHEMISTRY:

Water quality is extremely important for the optimum performance of your UV system. The following levels are recommended for installation:

- **Iron:** < 0.3 ppm (0.3 mg/L)
- **Hardness\*:** < 7 gpg (120 mg/L)
- **Turbidity:** < 1 NTU
- **Manganese:** < 0.05 ppm (0.05 mg/L)
- **Tannins:** < 0.1 ppm (0.1 mg/L)
- **UV Transmittance:** > 75% (call factory for recommendations on applications where UVT < 75%)

*\* Where total hardness is less than 7 gpg, the UV unit should operate efficiently provided the quartz sleeve is cleaned periodically. If total hardness exceeds 7 gpg, the water should be softened.*

If your water chemistry contains levels in excess of those mentioned above, proper pre-treatment is recommended to correct these water problems prior to the installation of your UV disinfection system. These water quality parameters can be tested by your local dealer, or by most private analytical laboratories. **Proper pre-treatment is essential for the UV disinfection system to operate as intended.**

## INSTALLING YOUR UV DISINFECTION SYSTEM:

- **CAUTION,** electronic ballast must be connected to a ground fault circuit interruptor (GFCI) receptacle and the lamp connector ground wire connected to the stainless steel reactor chamber.
- The disinfection system is designed to be mounted either horizontally or vertically at the point-of-entry.  
**Note:** The ideal installation is vertical with the lamp connector on top. This is to prevent water damage from occurring on the lamp pins and lamp connector.
- The ballast should be mounted either above or beside the reactor chamber. This will prevent moisture caused by condensation from entering the ballast enclosure, causing a potential for ballast failure.
- The complete water system, including any pressure or hot water tanks, must be sterilized before start up by flushing with chlorine (household bleach) to destroy any residual contamination.
- The disinfection system is intended for indoor use only, do not install disinfection system where it may be exposed to the weather.
- Install the disinfection system on cold water line only.
- If treating the entire house, install the disinfection system before any branch lines.
- A 5 micron sediment filter must precede the disinfection system. Ideally, the disinfection system should be the last treatment the water receives before it reaches the faucet.

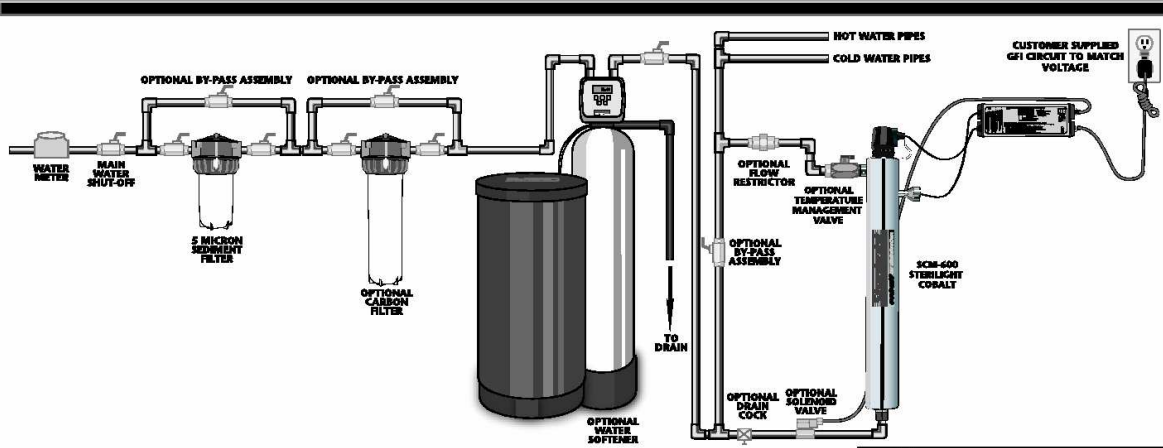

1. The above picture shows the installation of a typical disinfection system and the related components that may be used for the installation. The use of a by-pass assembly is recommended in case the system requires "off-line" maintenance. If this is the case, it must be noted that the system will require supplementary disinfection of the distribution system if any water is used during this by-pass condition. In addition, during by-pass, the water will NOT be disinfected and the attached "DO NOT CONSUME THE WATER" tag (included with the system), should be physically installed on the by-pass assembly until such time as the system is sanitized and returned to service. Please refer to the complete disinfection procedure as outlined on page 6 of this document. If the water is to be consumed while the system is off-line, the water must be boiled for twenty minutes prior to consumption.

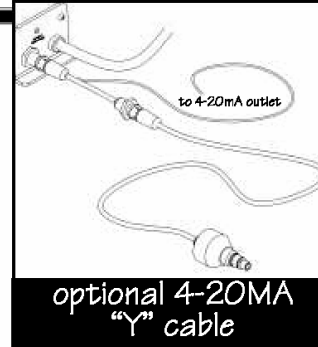

2. Select a suitable location for the disinfection system and its related components. As it is recommended to install a ground fault protected circuit (GFCI), make sure that this is taken into consideration prior to any installation. The system can either be installed vertically (inlet port at the bottom) (Figure 1A), or horizontally (Figure 1B). However, the vertical installation with the lamp connector on top is the most preferred method. When selecting a mounting location, you must also leave enough space to allow for the removal of the UV lamp and/or quartz sleeve (typically leave a space equal to the size of the reactor chamber itself).

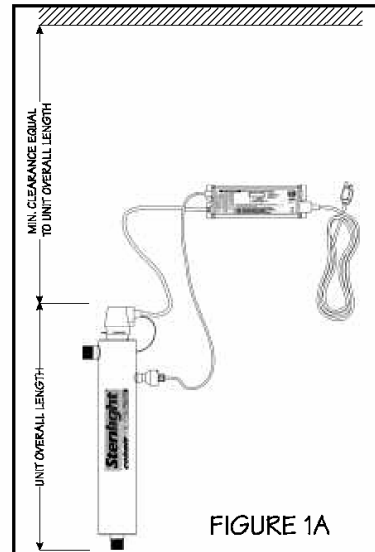

FIGURE 1A

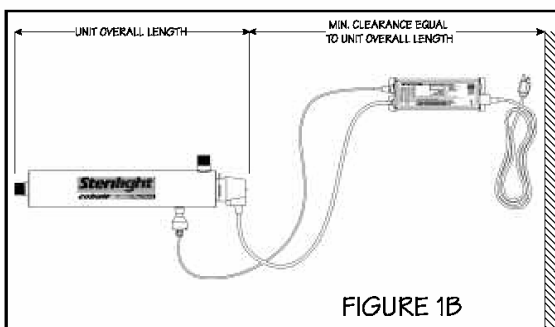







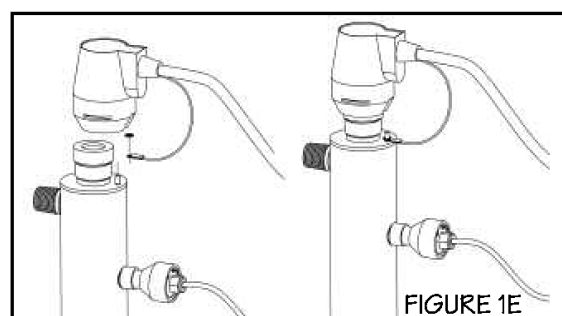
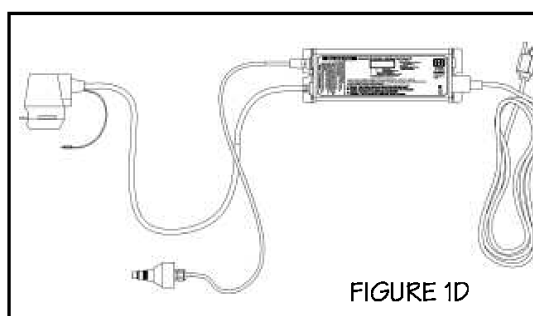
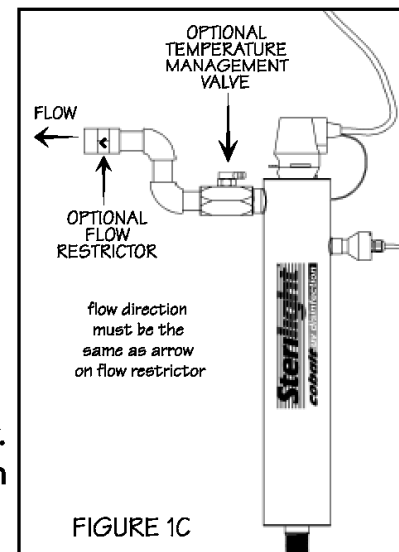

FIGURE 1B

(Note: Installation drawings show Cobalt "PLUS" system with UV sensor for representation purpose only)

3.  Mount the system to the wall using the supplied clamps. Various connection methods can be used to connect the water source to the system, however union type connectors are recommended. The use of a flow restrictor device is strongly recommended when installing your system in order to maintain the manufacturers rated flow rate. The flow restrictor should be installed on the outlet port and is designed to be installed in one direction only. Ensure that the flow of the water matches the flow direction as indicated on the flow restrictor (Figure 1C). **DO NOT SOLDER CONNECTIONS WHILE ATTACHED TO THE SYSTEM AS THIS COULD DAMAGE THE O-RING SEALS.**
4.    Mount the Cobalt ICE controller horizontally to the wall, near the reactor chamber. Ideally place the controller above the reactor and away from any water connection point, to prevent any water from potentially leaking onto the controller by means of a leak at a connection point or a "sweating" system. Make sure you allow for a "drip-loop" (Figure 1D) on the lamp, sensor and power cord, again, to prevent any water from potentially entering the controller. Affix the green ground wire to the grounding lug at the top of the reactor vessel and securely fasten with the retaining nut provided (Figure 1E).
5. Install the UV lamp and UV sensor as outlined on pages 7-9.
6. Install the over-molded lamp connector as outlined on page 7.
7.  When all plumbing connections are made, slowly turn on the water supply and check for leaks. The most likely cause for leaks is from the o-ring seal. In case of a leak, shut water off, drain cell, remove the retaining nut, wipe the o-ring and threads clean and re-install.
8.    Once it is determined that there are no leaks, plug the system into the ground fault interrupter, and check controller to ensure the system is operating properly. The controller is designed to detect both power to the system and lamp illumination. It is important to **NEVER LOOK DIRECTLY AT THE BURNING UV LAMP.**
9. Allow the water to run for a few minutes to clear any air or dust that may be in the reactor. **PLEASE NOTE:** When there is no flow, the water in the cell will become warm, as the UV lamp is always on. To remedy this, run a cold water tap anywhere in the house for a minute to flush out the warm water or purchase the optional temperature management valve (PN 440179). The temperature management valve will automatically flush the chamber when the water temperature is too high.





## DISINFECTION PROCEDURE:

UV disinfection is a physical disinfection process and does not add any potentially harmful chemicals to the water. As UV does not provide a disinfection residual, it is imperative that the entire distribution system located after the UV be chemically disinfected to ensure that the water is free from any bacteriological contaminants. The disinfection process must be performed immediately after the UV unit is installed and repeated thereafter whenever the UV is shut down for service, without power, or inoperative for any reason. The procedure for sanitizing the plumbing system is readily accomplished as follows:

1. Remove the pre-filter cartridge and fill the sump with 1-2 cups of household (5.25%) bleach (chlorine) – Do **NOT** use hydrogen peroxide. At all times during this process, make sure the UV unit (and lamp) is turned on and operational!
2. Open every faucet and allow cold water to run until the chlorine is detected. When you smell chlorine, shut the faucet off and then repeat the process on the hot water side. You must ensure that all taps, including outside faucets, dishwashers, showerheads, washing machines, connections to refrigerators, toilets, etc., pass chlorinated water.
3. Once all the locations have passed the chlorine disinfection solution, you will need to leave the solution sit for a period of 20 – 30 minutes. Reinstall the pre-filter cartridge into the filter and then flush the chlorine solution from the system. Make sure that each fixture that was disinfected in step two is completely flushed of the chlorine solution as the consumption of this water is not advised due to the extremely high concentrations of chlorine. It is important to remember that in the event that a UV is briefly shut down for routine cleaning or during power interruptions where water could have passed through the system, the aforementioned procedure must also be followed.
4. The addition of chlorine (bleach) to a hot water tank that has in the past been fed with untreated raw water with high levels of other contaminants (iron, manganese, hydrogen sulphide, organics, etc.) will result in oxidation of these contaminants and may require repeated flushing of the hot water tank. This contingency must be dealt with independently under the start-up procedure for any other conditioners that may form a part of the pre-treatment for the UV unit.
5. The above procedure (Steps 1 to 3) will result in a massive chlorine residual far in excess of the 0.5 to 1.0 mg/L typically present in municipally chlorinated water and of a magnitude consistent with the minimum 50 mg/L chlorine solution recommended for the disinfection of distribution systems known to be contaminated.

**PLEASE NOTE:** As the Cobalt “PLUS” systems include a 254nm UV intensity monitor, it should be noted that the introduction of the bleach solution required for disinfection **WILL** trigger a temporary low UV condition. This is due to the fact that the bleach physically “clouds” the raw water. Once the bleach runs through the system, the alarm condition will return to normal. During this sanitization process, the audible alarm condition on the Cobalt “PLUS” controller can be temporarily deferred by pressing the “RESET” switch for 5 seconds, then release it. By doing this, the audible alarm will be silenced and the solenoid relay will close (AC power will be provided to the normally closed (NC) solenoid, allowing water to pass through the system). The system will display R2 on the controller LED. This condition will remain for 12 hours unless the system is manually reset as outlined on page 10 of this manual or the power to the unit is disrupted.

## OPERATION

- Always disconnect power before performing any work on the disinfection system.
- Regularly inspect your disinfection system to ensure that the system is operational.
- Replace the UV lamp annually (or biennially if seasonal home use) to ensure maximum disinfection.
- Always drain the reactor chamber when closing a seasonal home or leaving the unit in an area subject to freezing temperatures.

## OPERATING & MAINTENANCE INSTRUCTIONS:



**Caution: PRIOR TO PERFORMING ANY WORK ON THE DISINFECTION SYSTEM, ALWAYS DISCONNECT THE POWER SUPPLY FIRST.**

### UV Lamp Replacement / Cleaning:

1. To replace the lamp, there is NO need to disconnect the system from the water supply, nor to drain the water from the reactor chamber. Lamp replacement is a quick and simple procedure requiring no special tools. The UV lamp must be replaced after 9,000 hours of continuous operation (approximately one year) in order to ensure adequate disinfection.
2. Disconnect main power source and allow the unit to power down. Remove the lamp connector by sliding the metal retaining ring (Figure 2A) away from the body of the connector. Remove connector and lamp from the reactor chamber. Separate the lamp from the connector (Figure 2B). Do not twist the lamp from the connector, simply slide the two apart. Avoid touching the lamp on the glass portion. Handling the lamp at the ceramic ends is acceptable, however if you must touch the lamp glass, please use gloves, or a soft cloth. Fully remove the lamp from the reactor chamber being careful not to angle the lamp as it is removed from the chamber. If the lamp is removed on an angle, pressure will be applied on the inside of the quartz sleeve, causing the sleeve to fracture.
3. To install a new lamp, first remove the lamp from its protective packaging, again being careful not to touch the lamp glass itself. Carefully insert the lamp into the reactor vessel (actually inside the quartz sleeve) (Figure 2C). Insert the lamp fully into the chamber leaving about two inches of the lamp protruding from the chamber. Next, attach the connector to the UV lamp (Figure 2B). The connector is “keyed” and will only allow correct installation in one position. Ensure the connector is fully seated onto the UV lamp (Figure 2D).

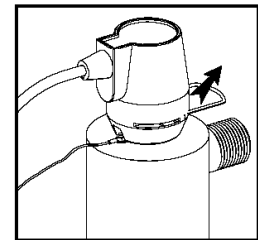

FIGURE 2A

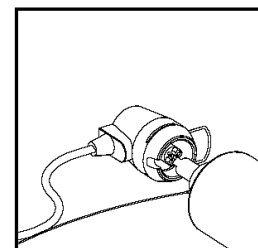

FIGURE 2B

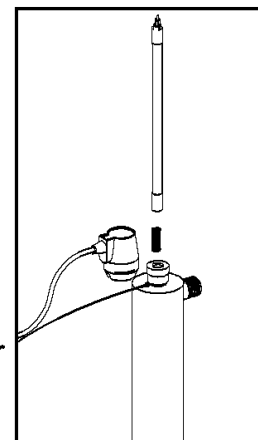

FIGURE 2C

- Once the lamp is fully seated on the connector, slide the connector over the aluminum retaining nut. Make sure the metal retaining ring on the connector is pulled away from the body of the connector in order that the connector may slide fully over the retaining nut. Once the connector is located fully over the retaining nut, slide the metal ring back in to lock the connector in place (Figure 2E). As this connector is keyed to the reactor chamber, make sure the notch on the connector (Figure 2A) is located over the ground lug located on the reactor chamber.

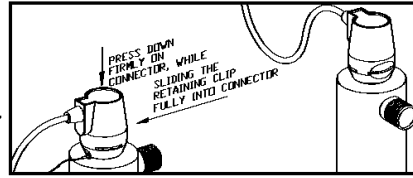

FIGURE 2E

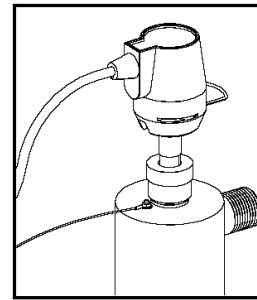

FIGURE 2D

### Quartz Sleeve Replacement / Cleaning:

- Mineral deposits and sediment may accumulate on the quartz sleeve decreasing the UV energy detected. Good maintenance of filtration equipment will reduce the accumulation of residues. If necessary, remove the quartz sleeve and clean with a commercially available scale remover (CLR, Lime-Away, etc.) and a lint free cloth. Repeat the process as often as necessary to keep the quartz sleeve clean. Be sure to remove all traces of cleaning fluid from the sleeve before it is reinstalled in the reactor (be sure not to allow liquid inside the sleeve).
- First follow the procedures as outlined in the "Lamp Replacement" section on page 7.
- Shut off the upstream water supply that feeds water into the reactor chamber.
- Shut off the downstream water supply. If your system does not have a separate downstream valve, simply open a downstream faucet to release any pressure that may be built-up in the system.
- After the UV lamp has been removed (Step 2), remove the aluminum retaining nut by turning counter clockwise (Figure 3a). Place a small pail under the reactor chamber to catch any water that may leak from the system. Grasp the quartz sleeve and fully remove from the reactor chamber. As with the lamp, make sure the sleeve is removed from the reactor chamber being careful not to angle the sleeve as it is removed from the reactor (Figure 3b). If the lamp is removed on an angle, pressure will be applied on the sides of the sleeve and against the reactor chamber, causing the sleeve to fracture.
- Clean the sleeve as outlined in Step one, or replace with a new sleeve. Reinstall the quartz sleeve in the reverse order. The Cobalt reactor is designed for easy installation of the quartz sleeve by incorporating a unique sleeve centering guide. To install the sleeve, carefully insert the sleeve into the reactor chamber (do not drop) and push the sleeve until it firmly seats in the end of the reactor centered in the sleeve centering guides (Figure 3c). Install a lubricated (silicone release grease) o-ring (Part number OR-212) onto the sleeve until it is positioned against the chamfered seat (Figure 3d).
- Reinstall the aluminum retaining nut on the reactor chamber and tighten by turning clockwise. The retaining nut should be hand-tightened only, the use of a wrench is not required, nor recommended. Reinstall the Safety-Loc™ connector as outlined in step four of the "Lamp Replacement" section.
- Slowly turn on water and pressurize the reactor to verify that there are no leaks.
- Reconnect to power source and follow the Controller start-up sequence to make sure the system is operating properly.

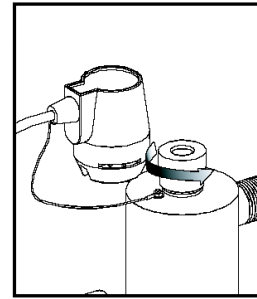

FIGURE 3A

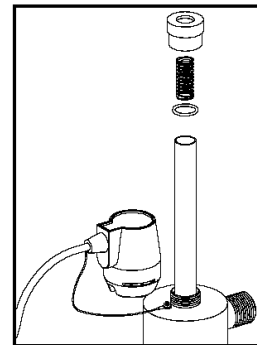

FIGURE 3B

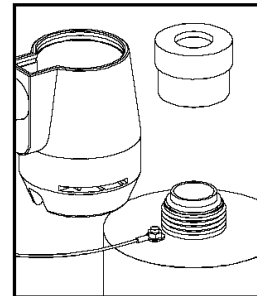

FIGURE 3C

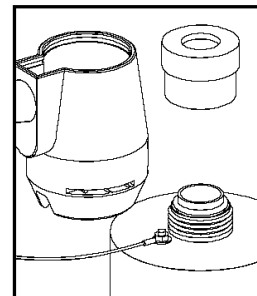

FIGURE 3D

## UV Sensor Replacement / Cleaning:



The UV sensor is an extremely sensitive and fragile instrument. Extreme care is required when handling and cleaning. The sensor window itself is constructed from quartz which is extremely fragile, be careful you do not chip or break this quartz window. Manufacturer's warranty does not cover damage due to neglect or misuse.

1. Mineral deposits and sediment may accumulate on the sensor window decreasing the UV energy detected. Good maintenance of pre-treatment equipment will reduce the accumulation of residues. If the system indicates that the UV intensity is low, one cause may be a stained quartz sleeve and/or sensor window (Figure 4A). If necessary, remove the sensor assembly and proceed with cleaning process. Repeat the process as often as necessary to keep the sensor window and quartz sleeve clean.
2. Before removing the sensor assembly, follow the steps as outlined in the "Quartz Sleeve Replacement And/Or Cleaning" section. The quartz sleeve should be cleaned at the same time as the UV sensor. Disconnect the UV sensor from the Cobalt "PLUS" (BA-ICE-CM) controller by disconnecting the sensor cable (Figure 4B). To remove the sensor, grasp the stainless portion of the sensor and rotate counter-clockwise (Figure 4C) until the sensor is free of the threaded sensor port.
3. Once the sensor is free from the reactor chamber, clean the quartz window with a commercial scale remover (CLR or Lime-A-Way) and a lint free cotton swab (Figure 4D). Follow all manufacturer's instructions regarding the cleaning fluid used. Do not use an abrasive cleaner on the sensor window. Scratching of the sensor window will void any manufacturer's warranty on this item.
4. Carefully reassemble the sensor assembly into the sensor boss by first inserting the sensor o-ring (Figure 4E) and then the sensor itself. Screw the sensor into the boss and tighten to achieve a water-tight seal. DO NOT OVER TIGHTEN. Attach the sensor cable to the Controller and return to service (Figure 4F).

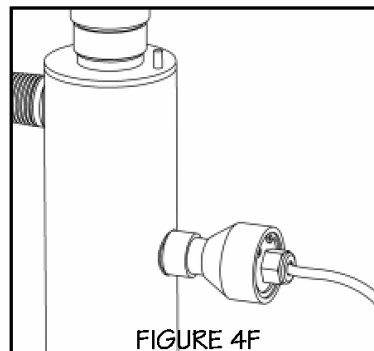
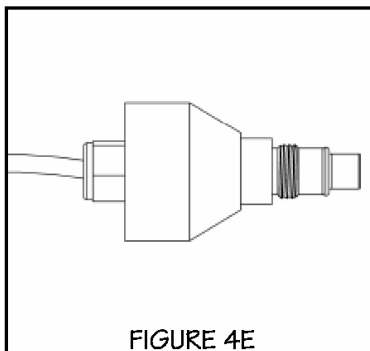
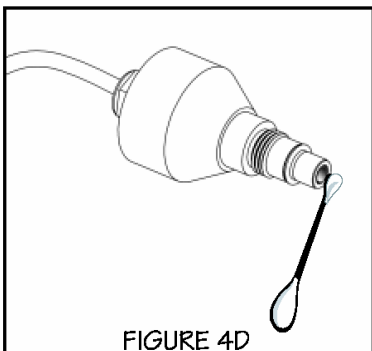
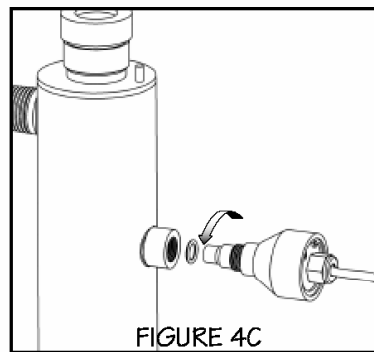
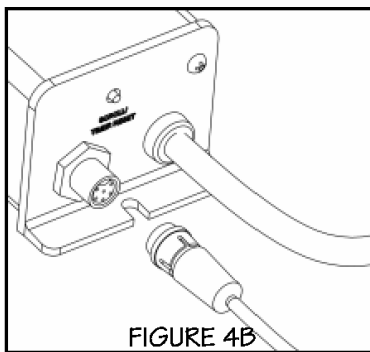
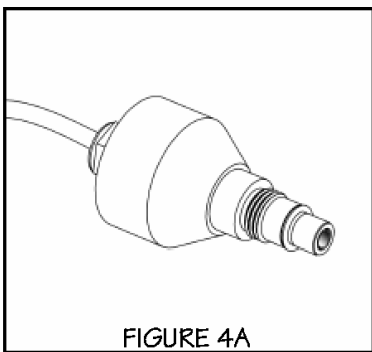

# OPERATION:

## Basic Systems incorporating BA-ICE-C controller:

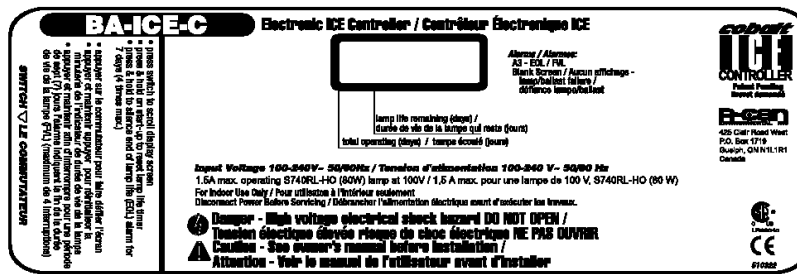

365

### 1. Lamp life remaining (days):

The controller tracks the number of days of operation of the lamp and the controller. The default screen will display the total lamp life remaining (in days). The controller will count down the number of days remaining until the lamp requires changing (365 days to 1 day). At "0" days, the controller will display A3 on the display and supply an intermittent audible chirp (1 second on, 5 seconds off), indicating the need to change the lamp.

**DEFERRAL** - Once the "A3" or end of lamp life message is shown on the LED screen, the audible alarm can be deferred up to 4 separate times. This can be done by simply depressing the push-button "RESET" switch for 5 seconds, which is located on the left side of the controller. Each time the reset switch is pressed the controller alarm is deferred seven days. Once the final 7 day deferral has been reached the alarm can only be silenced by changing the UV lamp and manually resetting the controller timer. To do this please follow the step by step instructions below:

1. disconnect power supply from controller
2. remove expired lamp from the reactor chamber
3. install new UV lamp and connect it to lamp connector
4. replace lamp connector
5. hold down the "RESET" switch while reapplying power to the controller
6. 5 second delay will occur until you hear an audible tone & LED display will read 365 once again

Once you hear the tone, let go of the switch and the counter will be reset. The delay switch is designed to allow you time to address the alarm while you obtain a new UV lamp. Even though the alarm on the system can be deferred for a period of time, it is important to address each and every alarm condition as they are indicating that there is a potential problem with the system and should be remedied.

1680

### 2. Total days of operation:

The controller also displays the total running time of the controller. To obtain this reading, press the push-button SWITCH once. The total running time of the controller will be numerically displayed in days. This information will remain displayed for ten seconds and will then revert back to the lamp life remaining default screen. It should be noted that this value cannot be reset.

### 3. Lamp failure (blank screen):

When the system recognizes LAMP FAILURE (no current running through the lamp), the 4-segment display will be blank (no default LAMP LIFE REMAINING screen) and the system will supply an intermittent audible tone (1 second on, 1 second off). The system will remain in this state, until this condition is remedied.

# "PLUS" Systems incorporating BA-ICE-CM controller:

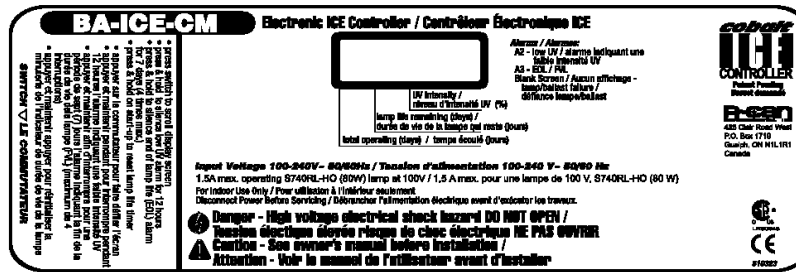

## 99 1. UV intensity (%):

The Cobalt "PLUS" series of products incorporate a UV sensor which detects the discrete 254 nm wavelength of the UV lamp. This information is relayed to the Cobalt "PLUS" controller and is the default display shown in "% UV output". The system will display the UV output between 50 to 99 percent. When the system drops below 50%, a low UV warning is displayed as R2 and alternately flashes (at 2 second intervals) back to the actual UV level. → Eg. 49 Additionally, the system will supply an intermittent audible tone (2 seconds on, 2 seconds off), during low UV conditions.

Note: UV levels of ...

65 to 99 Indicates the system is functioning within normal a normal operating range.

56 to 64 Indicates the UV level is still within a safe level, however at this level the system should be examined to determine why the UV level is this low.

50 to 55 Indicates the UV level is nearing the point of unsafe UV intensity, at this level the system should be CLOSELY examined to determine why the UV level is this low.

< 49 Indicates the UV level has now reached a level that is unsafe. At this level the water should not be consumed. The system/water supply should be examined to determine the reason for the low UV level of the UV intensity. At this level, the solenoid output has been activated and if a solenoid is installed, water will cease to flow.

**DEFERRAL** - To temporarily defer the audible alarm during a low UV alarm, press the push-button "RESET" switch and hold for five seconds, then release it. This will mute the audible alarm condition for 12 hours.



This advanced warning system has been installed to provide you with the optimum protection against microbiological contamination in your water.

**DO NOT DISREGARD THE WARNING SIGNALS.**

The best way to ensure optimum UV performance is to have the water microbiologically tested by a recognized testing agency on a regular basis.

**Possible causes for low uv alarm conditions:**

- i) The UV lamp has perhaps reached a level whereby it can no longer adequately provide a sufficient level of disinfection due to age (> 9000 hours). The lamp should be replaced with a new lamp from the manufacturer of the same size and type.
- ii) The quartz sleeve and/or the sensor window have become stained or dirty. Mineral deposits or sediment in the water that was not detected during the original water analysis may be the cause for this.
- iii) Intermittent voltage drop in the household power supply reducing the lamp output. The lamp will return to normal when the power is restored to full voltage. *Note: the monitoring system will not operate during power failures.*
- iv) The quality of the influent water has changed and is no longer within the acceptable operational range of the UV system. Perform a water analysis to determine the exact constituents and concentration levels.

**365** 2. **Lamp life remaining (days):**

To obtain this reading, press the push-button SWITCH a single time and follow the steps as outlined on page 10, regarding the operation of this feature.

**1680** 3. **Total days of operation:**

To obtain this reading, press the push-button SWITCH two times in succession and follow steps as outline on page 10, regarding the operation of this feature.

**Blank screen** 4. **Lamp failure (blank screen):**

Please refer to page 10 for explanation of this feature.  
Note: On the Cobalt "PLUS" systems, the audible tone provided for lamp failure is a continuous alarm, rather than the intermittent (1 second on, 1 seconds off) condition on the basic Cobalt systems.

**5. Solenoid Output:**

Working in conjunction with the UV intensity monitor, the Cobalt "PLUS" controller provides a powered, male IEC, solenoid (line voltage) connection (note: this is NOT a dry contact). In addition, this solenoid connection is protected with a replaceable 2 amp isolated fuse. When the UV intensity monitor senses that the water is not adequately being treated and drops to 49% UV intensity or below , the internal relay is opened thereby stopping AC power flowing to the normally closed solenoid valve. The valve will remain closed (no power) until the UV level rises above 49%, at which time the solenoid will open, allowing for water to pass through. To temporarily defer the operation of this solenoid output for up to 12 hours, please refer to the instructions outlined on page 11 of this manual. **NOTE: DURING BYPASS, THE "DO NOT CONSUME THE WATER" tag included with this manual should be placed in a prominent location and the water should NOT be consumed until the system has returned to a safe condition.**

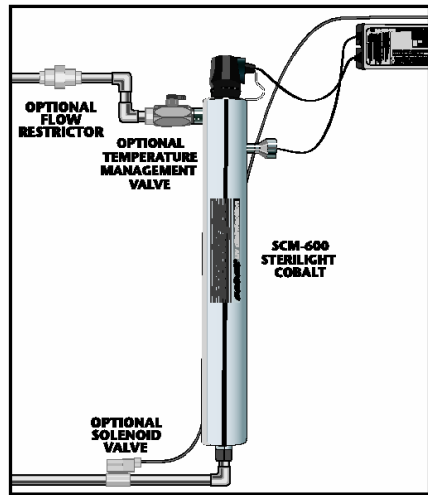

SOLENOID INSTALLATION

#### 6. 4-20mA output (optional):

For those looking for the capability to transmit the UV intensity data to a remote location via a 4-20 mA signal, an optional "Y" cable is available from your dealer (Figure 5A). Please order PN 260134. This "Y" cable comes with 20 meters (65') of cable for the 4-20 mA signal. To install, first remove the existing sensor cable from the Cobalt "Plus" controller (Figure 5B) and affix the new "Y" cable (Figure 5C). Next, attach the "male" end of the existing sensor cable to the "female" end of the new "Y" cable. Appropriately attach the 4-20 mA cable to the applicable equipment and ensure all connections are hand-tight.

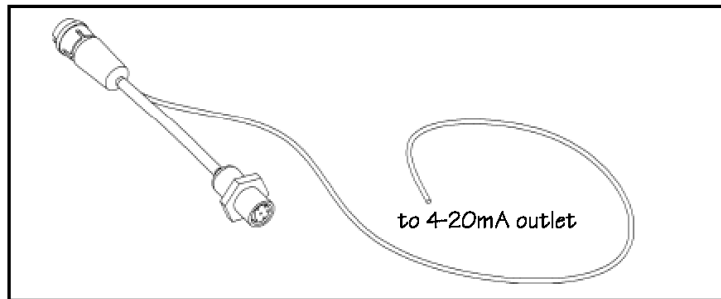

FIGURE 5A

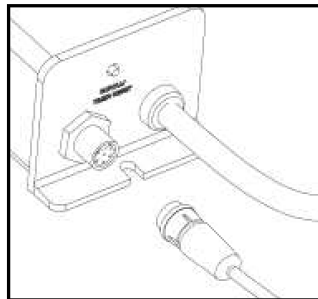

FIGURE 5B

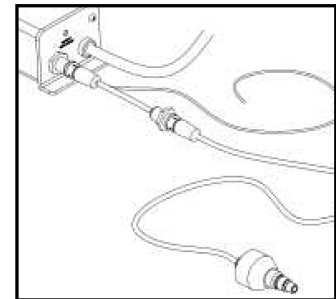

FIGURE 5C

## TROUBLESHOOTING:

- Your new Sterilight Cobalt disinfection system includes an indicator to advise when the water temperature has exceeded 40°C (104°F).
- When the water temperature exceeds the maximum rating, the controller will indicate a unique type of indicator by displaying 0 t, to give explicit indication of the "Over-Temperature" condition.
- If this over-temperature condition has been caused by extended time periods of no water flow (it is natural for the UV chamber to warm-up in such cases), simply open a faucet and allow some water to flow through the system.



# TROUBLESHOOTING:

<b>TROUBLESHOOTING GUIDE</b>		
<b>Symptom</b>	<b>Possible Causes</b>	<b>Solutions</b>
<b>Pressure Drop</b>	<ul style="list-style-type: none"> <li>• sediment pre-filter clogged</li> </ul>	<ul style="list-style-type: none"> <li>• replace filter cartridge with appropriate 5 micron cartridge</li> </ul> <p>Note: check source water supply as fluctuations may occur in source pressure</p>
	<ul style="list-style-type: none"> <li>• flow regulator</li> </ul>	<ul style="list-style-type: none"> <li>• flow regulator will result in pressure drop when approaching full flow</li> </ul>
<b>High Bacteria Counts</b>	<ul style="list-style-type: none"> <li>• Quartz sleeve is stained or dirty</li> </ul>	<ul style="list-style-type: none"> <li>• clean sleeve with scale cleaner and eliminate source of staining problem (ie. soften hard water)</li> </ul>
	<ul style="list-style-type: none"> <li>• change in feedwater quality</li> </ul>	<ul style="list-style-type: none"> <li>• have source water tested to ensure that water quality is still within allowable limits for this system</li> </ul>
	<ul style="list-style-type: none"> <li>• contamination in water lines after UV system</li> </ul>	<ul style="list-style-type: none"> <li>• it is imperative that effluent water stream be shocked with chlorine (bleach) before water leaves UV system - disinfection system must have a bacterial free distribution system to work effectively</li> </ul>
	<ul style="list-style-type: none"> <li>• possible break-through of sediment through pre-filter</li> </ul>	<ul style="list-style-type: none"> <li>• have source water tested for turbidity - may need stepped filtration in order to catch all sediment entering water system (20 micron filter followed by a 5 micron filter followed by UV system)</li> </ul>
<b>Heated Product Water</b>	<ul style="list-style-type: none"> <li>• common problem caused by infrequent use of water</li> </ul>	<ul style="list-style-type: none"> <li>• run water until it return to ambient temperature</li> </ul>
<b>Water Appears Milky</b>	<ul style="list-style-type: none"> <li>• caused by air in the water lines</li> </ul>	<ul style="list-style-type: none"> <li>• run water until air is purged</li> </ul>
<b>Unit Leaking Water</b>	<ul style="list-style-type: none"> <li>• problem with o-ring seal (on gland nut and/or UV sensor)</li> </ul>	<ul style="list-style-type: none"> <li>• ensure o-ring is in place, check for cuts or abrasions, clean o-ring, moisten with water and re-install, replace if necessary (OR-212)</li> </ul>
	<ul style="list-style-type: none"> <li>• condensation on reactor chamber caused by excessive humidity &amp; cold water</li> </ul>	<ul style="list-style-type: none"> <li>• check location of disinfection system and control humidity</li> </ul>
	<ul style="list-style-type: none"> <li>• inadequate inlet/outlet port connections</li> </ul>	<ul style="list-style-type: none"> <li>• check thread connections, reseal with Teflon® tape and re-tighten</li> </ul>
<b>System Shutting Down Intermittently</b>	<ul style="list-style-type: none"> <li>• interrupted power supply</li> </ul>	<ul style="list-style-type: none"> <li>• ensure system has been installed on its own circuit, as other equipment may be drawing power away from UV (ie. pump or fridge)</li> <li>• UV system should not be installed on a circuit which is incorporated into a light switch</li> </ul>
<b>Lamp Failure Alarm on - New Lamp</b>	<ul style="list-style-type: none"> <li>• loose connection between lamp and connector</li> </ul>	<ul style="list-style-type: none"> <li>• disconnect lamp from connector and reconnect, ensuring that a tight fit is accomplished</li> </ul>
	<ul style="list-style-type: none"> <li>• moisture build up in connector may keep lamp and connector from making a solid connection</li> </ul>	<ul style="list-style-type: none"> <li>• eliminate chance of any moisture getting to the connector and/or lamp pins</li> </ul>

## DISPLAY FAULT MODES

<p><b>LED display reads "A3"</b></p>	<ul style="list-style-type: none"> <li>• lamp life expired - countdown is at "0" days</li> <li>• press reset button for a deferred alarm, replace UV lamp</li> </ul>
<p><b>LED display is blank</b></p>	<ul style="list-style-type: none"> <li>• controller is in lamp failure mode</li> <li>• power system down, allowing it to reset itself; apply power in order to confirm that the controller is able to power lamp</li> <li>• check to see if there is sufficient power to the UV system</li> </ul>
<p><b>Low UV level displayed on screen</b></p>	<ul style="list-style-type: none"> <li>• test water supply to see if water quality meets recommended parameter limits</li> <li>• clean quartz sleeve and sensor eye</li> </ul>
<p><b>LED flashing "A2" and then back to UV level</b></p>	<ul style="list-style-type: none"> <li>• low UV alarm deferral has been activated</li> <li>• UV level has dropped below 50% and the audible alarm has been muted by pressing the reset switch and holding it for 5 seconds</li> <li>• this audible alarm deferral will only last 12 hours</li> </ul>

## COBALT SERIES DOSE FLOW CHART:

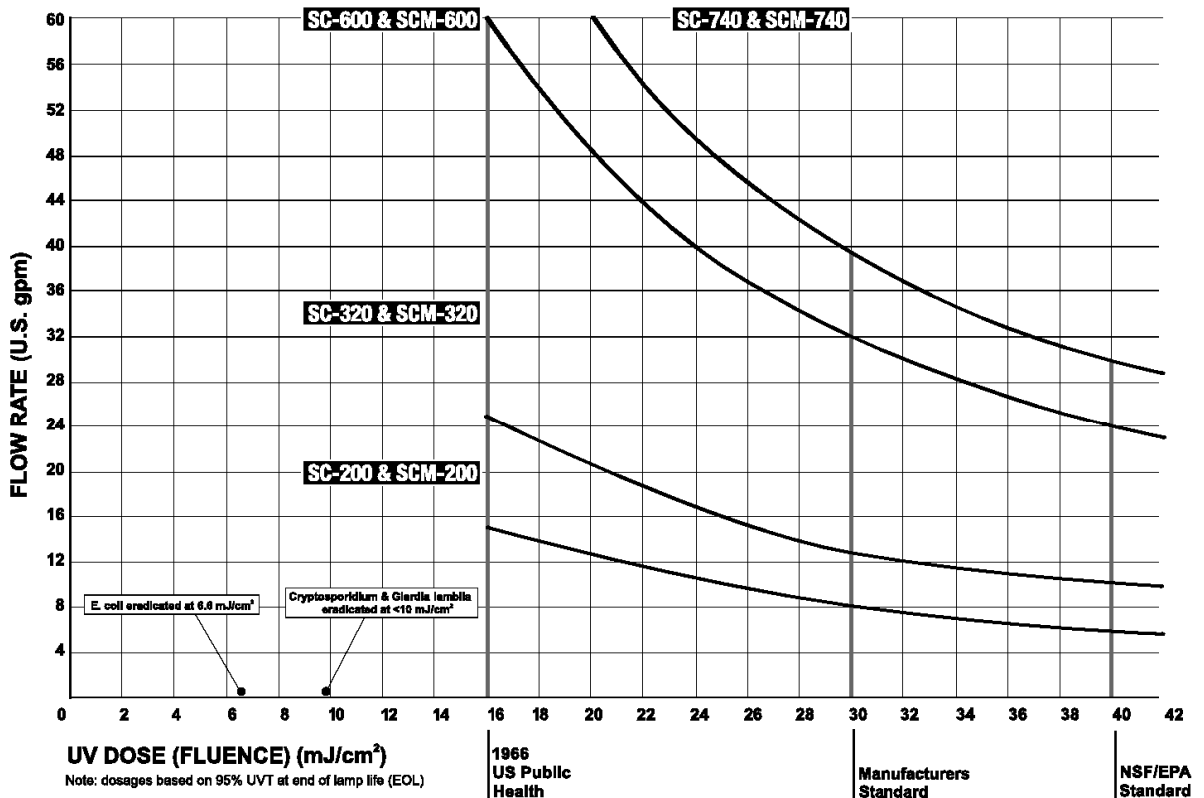

# SPECIFICATIONS COBALT "BASIC":

MODEL		SC-200	SC-320	SC-600	SC-740
<b>Flow Rate<sup>1</sup></b>	<b>US Public Health 16 mJ/cm<sup>2</sup></b>	56.8 lpm (15 gpm) (3.4 m <sup>3</sup> /Hr.)	94.6 lpm (25 gpm) (5.7 m <sup>3</sup> /Hr.)	227.1 lpm (60 gpm) (13.6 m <sup>3</sup> /Hr.)	227.1 lpm (60 gpm) (13.6 m <sup>3</sup> /Hr.)
	<b>R-Can Standard 30 mJ/cm<sup>2</sup></b>	30.3 lpm (8 gpm) (1.8 m <sup>3</sup> /Hr.)	49.2 lpm (13 gpm) (3 m <sup>3</sup> /Hr.)	121.1 lpm (32 gpm) (7.3 m <sup>3</sup> /Hr.)	151.4 lpm (40 gpm) (9.1 m <sup>3</sup> /Hr.)
	<b>NSF/EPA 40 mJ/cm<sup>2</sup></b>	22.7 lpm (6 gpm) (1.4 m <sup>3</sup> /Hr.)	37.8 lpm (10gpm) (2.3 m <sup>3</sup> /Hr.)	90.8 lpm (24 gpm) (5.5 m <sup>3</sup> /Hr.)	113.6 lpm (30 gpm) (6.8 m <sup>3</sup> /Hr.)
<b>Dimensions</b>	<b>Reactor</b>	45.2 cm x 8.9 cm (17.8" x 3.5")	57.9 cm x 8.9 cm (22.8" x 3.5")	78.0 cm x 8.9 cm (30.7" x 3.5")	100.1 cm x 8.9 cm (39.7" x 3.5")
	<b>Controller</b>	22.8 cm x 8.9 cm x 5.3 cm (9" x 3.5" x 2")	22.8 cm x 8.9 cm x 5.3 cm (9" x 3.5" x 2")	22.8 cm x 8.9 cm x 5.3 cm (9" x 3.5" x 2")	22.8 cm x 8.9 cm x 5.3 cm (9" x 3.5" x 2")
<b>Inlet/Outlet Port Size</b>		Combo 3/4" FNPT/ 1" MNPT	1" MNPT	1" MNPT	1" MNPT
<b>Shipping Weight</b>		5.4 kg (12 lbs.)	6.8 kg (15 lbs.)	8.6 kg (19 lbs.)	10.9 kg (24 lbs.)
<b>Electrical</b>	<b>Voltage</b>	100-240V./ 50-60Hz	100-240V./ 50-60Hz	100-240V./ 50-60Hz	100-240V./ 50-60Hz
	<b>Power Consumption</b>	35 W	42 W	73 W	88 W
	<b>Lamp Watts</b>	30 W	36 W	65 W	80 W
<b>Maximum Operating Pressure</b>		8.62 bar (125 psi)	8.62 bar (125 psi)	8.62 bar (125 psi)	8.62 bar (125 psi)
<b>Ambient Water Temperature</b>		2-40°C (36-104°F)	2-40°C (36-104°F)	2-40°C (36-104°F)	2-40°C (36-104°F)
<b>Lamp Type</b>		Sterilume™-HO (high-output)			
<b>Visual "Power-On"</b>		Yes	Yes	Yes	Yes
<b>Audible Lamp Failure</b>		Yes	Yes	Yes	Yes
<b>Lamp Replacement Reminder</b>		Yes	Yes	Yes	Yes
<b>Visual Lamp Life Remaining</b>		Yes	Yes	Yes	Yes
<b>Total Running Time</b>		Yes	Yes	Yes	Yes
<b>254nm UV Monitor</b>		No	No	No	No
<b>Powered Solenoid Output</b>		No	No	No	No
<b>4-20 mA Output</b>		No	No	No	No
<b>Chamber Material<sup>2</sup></b>		304 S.S. <sup>2</sup>	304 S.S. <sup>2</sup>	304 S.S. <sup>2</sup>	304 S.S. <sup>2</sup>

<sup>1</sup>. Flow rates stated @ 95% UVT EOL

<sup>2</sup>. 316L stainless steel available on request

# SPECIFICATIONS COBALT "PLUS":

MODEL		SCM-200	SCM-320	SCM-600	SCM-740
<b>Flow Rate<sup>1</sup></b>	<b>US Public Health 16 mJ/cm<sup>2</sup></b>	56.8 lpm (15 gpm) (3.4 m <sup>3</sup> /Hr.)	94.6 lpm (25 gpm) (5.7 m <sup>3</sup> /Hr.)	227.1 lpm (60 gpm) (13.6 m <sup>3</sup> /Hr.)	227.1 lpm (60 gpm) (13.6 m <sup>3</sup> /Hr.)
	<b>R-Can Standard 30 mJ/cm<sup>2</sup></b>	30.3 lpm (8 gpm) (1.8 m <sup>3</sup> /Hr.)	49.2 lpm (13 gpm) (3 m <sup>3</sup> /Hr.)	121.1 lpm (32 gpm) (7.3 m <sup>3</sup> /Hr.)	151.4 lpm (40 gpm) (9.1 m <sup>3</sup> /Hr.)
	<b>NSF/EPA 40 mJ/cm<sup>2</sup></b>	22.7 lpm (6 gpm) (1.4 m <sup>3</sup> /Hr.)	37.8 lpm (10gpm) (2.3 m <sup>3</sup> /Hr.)	90.8 lpm (24 gpm) (5.5 m <sup>3</sup> /Hr.)	113.6 lpm (30 gpm) (6.8 m <sup>3</sup> /Hr.)
<b>Dimensions</b>	<b>Reactor</b>	45.2 cm x 8.9 cm (17.8" x 3.5")	57.9 cm x 8.9 cm (22.8" x 3.5")	78.0 cm x 8.9 cm (30.7" x 3.5")	100.1 cm x 8.9 cm (39.7" x 3.5")
	<b>Controller</b>	22.8 cm x 8.9 cm x 5.3 cm (9" x 3.5" x 2")	22.8 cm x 8.9 cm x 5.3 cm (9" x 3.5" x 2")	22.8 cm x 8.9 cm x 5.3 cm (9" x 3.5" x 2")	22.8 cm x 8.9 cm x 5.3 cm (9" x 3.5" x 2")
<b>Inlet/Outlet Port Size</b>		Combo 3/4" FNPT/ 1" MNPT	1" MNPT	1" MNPT	1" MNPT
<b>Shipping Weight</b>		5.9 kg (13 lbs.)	7.3 kg (16 lbs.)	9.1 kg (20 lbs.)	11.3 kg (25 lbs.)
<b>Electrical</b>	<b>Voltage</b>	100-240V./ 50-60Hz	100-240V./ 50-60Hz	100-240V./ 50-60Hz	100-240V./ 50-60Hz
	<b>Power Consumption</b>	35 W	42 W	73 W	88W
	<b>Lamp Watts</b>	30 W	36 W	65 W	80 W
<b>Maximum Operating Pressure</b>		8.62 bar (125 psi)	8.62 bar (125 psi)	8.62 bar (125 psi)	8.62 bar (125 psi)
<b>Ambient Water Temperature</b>		2-40°C (36-104°F)	2-40°C (36-104°F)	2-40°C (36-104°F)	2-40°C (36-104°F)
<b>Lamp Type</b>		Sterilume™-HO (high-output)			
<b>Visual "Power-On"</b>		Yes	Yes	Yes	Yes
<b>Audible Lamp Failure</b>		Yes	Yes	Yes	Yes
<b>Lamp Replacement Reminder</b>		Yes	Yes	Yes	Yes
<b>Visual Lamp Life Remaining</b>		Yes	Yes	Yes	Yes
<b>Total Running Time</b>		Yes	Yes	Yes	Yes
<b>254nm UV Monitor</b>		Yes	Yes	Yes	Yes
<b>Powered Solenoid Output</b>		Yes	Yes	Yes	Yes
<b>4-20 mA Output</b>		Yes (optional 260134)	Yes (optional 260134)	Yes (optional 260134)	Yes (optional 260134)
<b>Chamber Material<sup>2</sup></b>		304 S.S. <sup>2</sup>	304 S.S. <sup>2</sup>	304 S.S. <sup>2</sup>	304 S.S. <sup>2</sup>

<sup>1</sup> Flow rates stated @ 95% UVT EOL

<sup>2</sup> 316L stainless steel available on request

## **MANUFACTURER'S WARRANTY:**

Manufacturer warrants the ultraviolet disinfection system hardware and electrical systems to be free from defects in material and workmanship for a period of five (5) years from the date of purchase by the original owner (consumer) on a pro-rated basis. Manufacturer warrants the ultraviolet lamps to be free from defects in material and workmanship for a period of one (1) year and the reactor chamber for a period of seven (7) years. The warrantor will at its option and expense, either repair or replace such units subject to the following conditions, exceptions, and exclusions.

### **CONDITIONS, EXCEPTIONS, AND EXCLUSIONS**

*The foregoing limited Warranty is subject to the following terms and conditions:*

1. Water passed through the unit must fall within the following parameters:
  - a) Iron: < 0.3 ppm (0.3 mg/L)
  - b) Hardness\*: < 7 gpg (120 mg/L)
  - c) Turbidity: < 1 NTU
  - d) Manganese: < 0.05 ppm (0.05 mg/L)
  - e) Tannins: < 0.1 ppm (0.1 mg/L)
  - f) UV Transmittance: > 75% (call factory for recommendations on applications where UVT < 75%)

*\* Where total hardness is less than 7 gpg, the UV unit should operate efficiently provided the quartz sleeve is cleaned periodically. If total hardness is over 7 gpg, the water should be softened. **Warranty will be void, if the proper steps are not taken to ensure that these impurities are not present.***
2. This limited Warranty shall not apply to any unit which has been repaired or altered by anyone other than the Warrantor or by a person authorized by the Warrantor, nor to any units which have been subject to misuse, neglect, or accident.
3. This limited Warranty runs exclusively to the original Consumer and with respect to the original installation only.
4. **WARRANTOR SHALL NOT BE LIABLE FOR ANY INCIDENTAL OR CONSEQUENTIAL DAMAGES.**
5. This limited Warranty excludes the cost of labour in removing any defective unit or installing any replacement unit. This limited Warranty applies only to a unit when returned to the Warrantor at the owner's expense and in accordance with shipping instructions received from the Warrantor.



**IMPORTANT NOTICE**  
 This card must be returned within (10) days of purchase or register your warranty on-line at [www.r-can.com](http://www.r-can.com).  
 PLEASE PRINT Thank you.

Model No. \_\_\_\_\_  
 (Must Specify)

Your Name: \_\_\_\_\_ E-mail Address: \_\_\_\_\_ DATE OF PURCHASE: Mo. \_\_\_\_\_ Yr. \_\_\_\_\_

Address: \_\_\_\_\_ Street \_\_\_\_\_ City \_\_\_\_\_ Prov./State & Postal Code/Zip \_\_\_\_\_

Telephone Number: (\_\_\_\_) \_\_\_\_\_

Dealer's Name: \_\_\_\_\_

Dealer's Address: \_\_\_\_\_ Street \_\_\_\_\_ City \_\_\_\_\_ Prov./State & Postal Code/Zip \_\_\_\_\_

1. Where is this unit to be used?
 

A <input type="checkbox"/> Apartment	B <input type="checkbox"/> Home	C <input type="checkbox"/> Farm	D <input type="checkbox"/> Motel/Hotel	E <input type="checkbox"/> Cottage	F <input type="checkbox"/> Boat
G <input type="checkbox"/> Condo	H <input type="checkbox"/> Business	I <input type="checkbox"/> Trailer/Mobile	J <input type="checkbox"/> Restaurant	K <input type="checkbox"/> Coffee Service	L <input type="checkbox"/> Institutional Kitchen
2. What type of store was this unit purchased?
 

M <input type="checkbox"/> Vending Machine	N <input type="checkbox"/> Convenience Store	O <input type="checkbox"/> Other (Specify) _____
--	--	--
3. What attracted your attention to this unit?
 

A <input type="checkbox"/> Plumbing	B <input type="checkbox"/> Hardware	C <input type="checkbox"/> Farm	D <input type="checkbox"/> Water Treatment	E <input type="checkbox"/> Lumber/Home Centre	F <input type="checkbox"/> Department Store
G <input type="checkbox"/> RV Sales	H <input type="checkbox"/> Food Service Sales	I <input type="checkbox"/> Vending Supply	J <input type="checkbox"/> Other (specify) _____		
4. What attracted your attention to this unit?
 

A <input type="checkbox"/> Store Display	B <input type="checkbox"/> Newspaper Ad	C <input type="checkbox"/> Magazine Ad	D <input type="checkbox"/> Catalogue	E <input type="checkbox"/> Plumber's Recommendation
F <input type="checkbox"/> Friend's Recommendation	G <input type="checkbox"/> Yellow Pages		H <input type="checkbox"/> Other (specify) _____	
5. Equipment installed primarily to treat?
 

A <input type="checkbox"/> Dirt	B <input type="checkbox"/> Rust	C <input type="checkbox"/> Algae	D <input type="checkbox"/> Chlorine Taste or Odour	E <input type="checkbox"/> Sulphur Taste or Odour	F <input type="checkbox"/> Iron
G <input type="checkbox"/> Hard Water/Scale	H <input type="checkbox"/> Corrosion	I <input type="checkbox"/> Chemicals	J <input type="checkbox"/> Microbiological Contaminants	K <input type="checkbox"/> Pool/Spa Treatment	L <input type="checkbox"/> Other (specify) _____
6. Filtered water needed primarily
 

A <input type="checkbox"/> Drinking	B <input type="checkbox"/> Beverages	C <input type="checkbox"/> Cooking	D <input type="checkbox"/> Laundry	E <input type="checkbox"/> Health or Medical Reasons
F <input type="checkbox"/> Shower/Bath	G <input type="checkbox"/> Toilet	H <input type="checkbox"/> Ice Machine	I <input type="checkbox"/> Coffee	J <input type="checkbox"/> Post Mix
7. What is your water source?
 

A <input type="checkbox"/> Public	B <input type="checkbox"/> Community Well	C <input type="checkbox"/> Your Own Well	D <input type="checkbox"/> Lake/River	E <input type="checkbox"/> Cistern	F <input type="checkbox"/> Other (specify) _____
-----------------------------------	---	--	---------------------------------------	------------------------------------	--
8. Do you have any other water treatment products? (specify) \_\_\_\_\_
9. Who installed your unit?
 

A <input type="checkbox"/> Yourself	B <input type="checkbox"/> Plumber	C <input type="checkbox"/> Other
-------------------------------------	------------------------------------	----------------------------------
10. Unit purchase price \_\_\_\_\_ Installation cost \_\_\_\_\_
11. Do you have, or use, bottled water?
 

A <input type="checkbox"/> Yes	B <input type="checkbox"/> No
--------------------------------	-------------------------------
12. Was this unit purchased to replace bottled water?
 

A <input type="checkbox"/> Yes	B <input type="checkbox"/> No
--------------------------------	-------------------------------

serial number required for warranty



**425 Clair Road West**  
**Guelph, ON N1L 1R1**  
**Canada**  
 t. 519.763.1032  
 t.f. 1.800.265.7246  
 f. 519.763.5069  
 e. [water@r-can.com](mailto:water@r-can.com)  
 i. [www.r-can.com](http://www.r-can.com)

**ensuring the safety of your water**

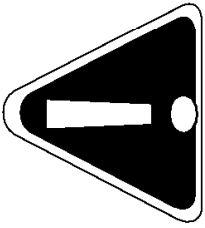

## **DO NOT CONSUME THE WATER**

The system has been placed on by-pass and as a result the water in this distribution system should not be consumed until the system has been fully sanitized and returned to service. Please refer to the Installation Manual for complete disinfection procedure.



Place  
Stamp  
Here

**R-Can Environmental Inc**  
**Warranty Department**  
P.O. BOX 1719  
GUELPH, ONTARIO  
N1H 6Z9