

Multi 3430



**Digital pH / dissolved oxygen /
conductivity meter
for 3 digital IDS sensors**

**Accuracy when
going to press**

The use of advanced technology and the high quality standard of our instruments are the result of a continuous development. This may result in differences between this operating manual and your meter. Also, we cannot guarantee that there are absolutely no errors in this manual. Therefore, we are sure you will understand that we cannot accept any legal claims resulting from the data, figures or descriptions.

Copyright

© Weilheim 2009, WTW GmbH
Reproduction in whole - or even in part - is prohibited without the express written permission of WTW GmbH, Weilheim.
Printed in Germany.

Multi 3430 - Contents

1	Overview	7
1.1	Keypad	8
1.2	Display	9
1.3	Socket field	11
1.4	Automatic sensor recognition	12
1.5	IDS sensors	12
2	Safety	15
2.1	Authorized use	16
2.2	General safety instructions	16
3	Commissioning	19
3.1	Scope of delivery	19
3.2	Power supply	19
3.3	Initial commissioning	19
3.3.1	Inserting the rechargeable batteries	19
3.3.2	Connecting the power pack / charging the batteries	20
3.3.3	Switching on the meter	21
3.3.4	Setting the date and time	21
4	Operation	23
4.1	Switching on the meter	23
4.2	General operating principles	24
4.2.1	Operating modes	24
4.2.2	Display of several sensors in the measuring mode 25	
4.2.3	Navigation	26
4.2.4	Example 1 on navigation: Setting the language	28
4.2.5	Example 2 on navigation: Setting the date and time	30
4.3	Sensor-independent settings	32
4.3.1	<i>System</i>	32
4.3.2	<i>Data storage</i>	34
4.3.3	<i>Automatic Stability control</i>	34
4.4	Sensor info	34
4.5	Channel display	35
4.6	pH value	36
4.6.1	General information	36
4.6.2	Measuring the pH value	37

4.6.3	Settings for pH measurements	39
4.6.4	pH calibration	41
4.6.5	Calibration interval	47
4.6.6	Carrying out an automatic calibration (AutoCal)	48
4.6.7	Carrying out a manual calibration (ConCal)	52
4.6.8	Displaying calibration records	54
4.6.9	Continuous measurement control (CMC function)	56
4.6.10	QSC function (sensor quality control)	57
4.7	ORP voltage	60
4.7.1	General information	60
4.7.2	Measuring the ORP	60
4.7.3	Settings for ORP measurements	62
4.8	Conductivity	63
4.8.1	General information	63
4.8.2	Measuring	63
4.8.3	Temperature compensation	66
4.8.4	Settings for IDS conductivity sensors	67
4.8.5	Determining the cell constant (calibration in control standard)	70
4.8.6	Displaying calibration records	72
4.9	Data storage	73
4.9.1	Manual storage	74
4.9.2	Automatic storage at intervals	75
4.9.3	Editing the measurement data storage	77
4.9.4	Erasing the measurement data storage	79
4.10	Transmitting data (USB interfaces)	80
4.10.1	Outputting current measurement data	80
4.10.2	Transmitting data (to a PC)	80
4.10.3	Connecting the PC / USB-B interface (<i>USB Device</i>)	80
4.10.4	Connecting the USB memory device / USB-A interface (<i>USB Host</i>)	81
4.10.5	Options for data transmission	82
4.11	Reset	83
4.11.1	Resetting the measurement settings	83
4.11.2	Resetting the system settings	85
5	Maintenance, cleaning, disposal	87
5.1	Maintenance	87
5.1.1	Replacing the rechargeable batteries	87
5.2	Cleaning	88
5.3	Packing	88
5.4	Disposal	88
6	What to do if...	89
6.1	General information	89

6.2	pH	90
6.3	Conductivity	92
7	Technical data	93
7.1	General data	93
7.2	Measuring ranges, resolution, accuracy	94
8	Lists	95
9	Appendix: Firmware update	99

1 Overview

The compact, digital precision meter Multi 3430 enables you to carry out pH measurements, ORP measurements, conductivity measurements and dissolved oxygen (D.O.) measurements quickly and reliably.

The Multi 3430 provides the maximum degree of operating comfort, reliability and measuring certainty for all applications.

The Multi 3430 supports you in your work with the following functions:

- proven calibration procedures
- automatic stability control (AR),
- automatic sensor recognition,
- CMC (continuous measurement control)
- QSC (sensor quality control).



1	Keypad
2	Display
3	Socket field





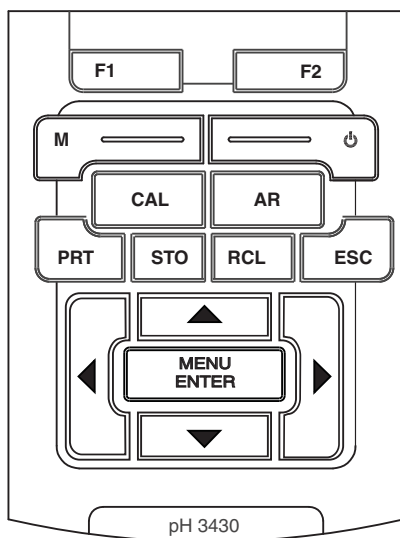

The two USB interfaces (USB-A and USB-B) enable you to:



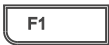

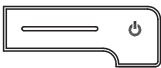
- Transmit data to
 - a USB memory device
 - a PC
- Update the meter firmware.

1.1 Keypad



In this operating manual, keys are indicated by brackets <..> . The key symbol (e.g. <MENU/ENTER>) generally indicates a short keystroke (under 2 sec) in this operating manual. A long keystroke (approx. 2 sec) is indicated by the underscore behind the key symbol (e.g. <MENU/ENTER__>).

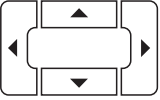

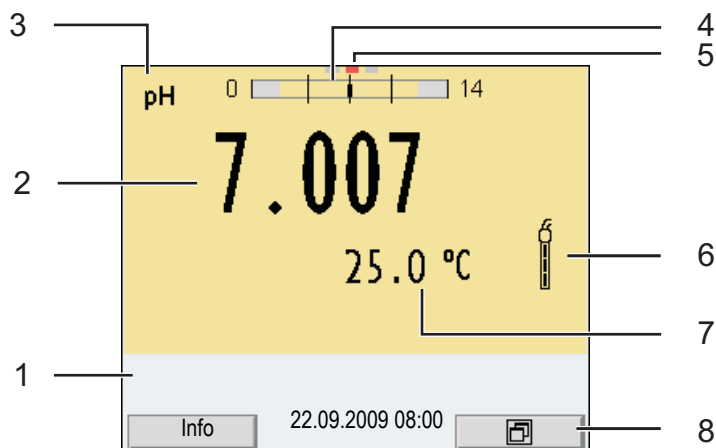

	<F1>: <F2>:	Softkeys providing situation dependent functions, e.g.: <F1>/[Info]: View information on a sensor
		
	<On/Off>:	Switches the meter on or off
	<M>:	Selects the measured parameter
	<CAL>: <CAL__>:	Calls up the calibration procedure Displays the calibration data
	<AR>	Freezes the measured value (HOLD function) Switches the AutoRead measurement on or off

	<STO> : <STO__> :	Saves a measured value manually Opens the menu for the automatic save function
	<RCL> : <RCL__> :	Displays the manually stored measured values Displays the automatically stored measured values
	<▲><▼> : <◀><▶> :	Menu control, navigation
	<MENU/ENTER> : <MENU/ENTER__> :	Opens the menu for measurement settings / Confirms entries Opens the menu for system settings
	<PRT> : <PRT__> :	Outputs stored data to the interface Outputs displayed data to the interface in intervals

1.2 Display



1	Status information
2	Measured value (with unit)
3	Measured parameter
4	Continuous measurement control (CMC function)
5	Channel display: Plug position of the sensor
6	Sensor symbol (calibration evaluation, calibration interval)
7	Measured temperature (with unit)
8	Softkeys and date + time

Function display indicators	Indicator	Description
	AutoCal e.g. TEC	Calibration with automatic buffer recognition, e.g. with the buffer set: Technical buffers
	ConCal	Calibration with any buffers
	Error	An error occurred during calibration
	AR	Stability control (AutoRead) is active
	HOLD	Measured value is frozen (<AR> key)
		Batteries are almost empty
		The batteries are being charged
		Data are automatically output to the USB-B interface at intervals
		Data are output to the USB-A interface (USB flash drive)
		Power supply via the USB-B interface Batteries are not being charged

1.3 Socket field

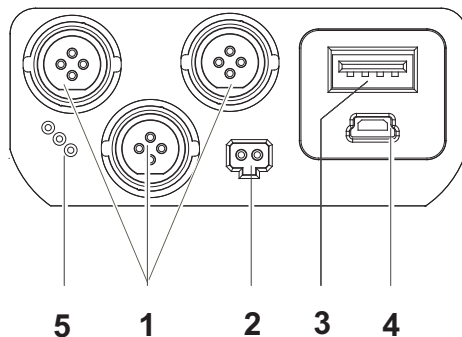

Connectors:

1	Digital sensors (pH, ORP, conductivity, D.O.)
2	Power pack
3	USB-A (Host) interface
4	USB B (Device) interface
5	Service interface



CAUTION

Only connect sensors to the meter that cannot return any voltages or currents that are not allowed ($> \text{SELV}$ and $>$ current circuit with current limiting).

WTW IDS sensors meet these requirements.

1.4 Automatic sensor recognition

The automatic sensor recognition for IDS sensors allows

- to operate an IDS sensor at different meters without recalibration
- to operate different IDS sensors at one meter without recalibration
- to assign measurement data to an IDS sensor
 - Measurement datasets are always stored and output with the sensor name and sensor series number.
- to assign calibration data to an IDS sensor
 - Calibration data and calibration history are always stored and output with the sensor name and sensor series number.
- to activate the correct cell constant for conductivity sensors automatically
- to hide menus automatically that do not concern this sensor

To be able to use the automatic sensor recognition, a meter that supports the automatic sensor recognition (e.g. Multi 3430) and a digital IDS sensor are required.

In digital IDS sensors, sensor data are stored that clearly identify the sensor.

The sensor data are automatically taken over by the meter.

1.5 IDS sensors

IDS sensors

- support the automatic sensor recognition
- show only the settings relevant to the specific sensor in the setting menu
- process signals in the sensor digitally so that precise and interference-free measurements are enabled even with long cables
- facilitate to assign a sensor to a measured parameter with differently colored couplings
- have quick-lock couplings with which to fix the sensors to the meter.



Note

Information on available IDS sensors is given on the Internet and in the WTW catalog, "Laboratory and field instrumentation".

Sensor data from IDS sensors

IDS sensors transmit the following sensor data to the meter:

- **SENSOR ID**
 - Sensor name
 - Sensor series number
- **Calibration data**
 - Calibration date
 - Calibration characteristics
 - Calibration interval
 - Selected buffer set (IDS pH sensors only)
 - Cell constant (IDS conductivity sensors only)
 - Calibration history of the last 10 calibrations
- **Measurement settings (IDS conductivity sensors only)**
 - The set measured parameter
 - The set reference temperature
 - The set temperature coefficient
 - The set TDS factor

The calibration data are updated in the IDS sensor after each calibration procedure. A message is displayed while the data are being updated in the sensor.

**Note**

In the measured value display, you can display the sensor name and series number of the selected sensor with the [Info] softkey. You can then display all further sensor data stored in the sensor with the [More] softkey.

2 Safety

This operating manual contains basic instructions that you must follow during the commissioning, operation and maintenance of the meter. Consequently, all responsible personnel must read this operating manual before working with the meter.

The operating manual must always be available within the vicinity of the meter.

Target group

The meter was developed for work in the field and in the laboratory. Thus, we assume that, as a result of their professional training and experience, the operators will know the necessary safety precautions to take when handling chemicals.

Safety instructions

Safety instructions in this operating manual are indicated by the warning symbol (triangle) in the left column. The signal word (e.g. "Caution") indicates the level of danger:



WARNING

indicates instructions that must be followed precisely in order to avoid possibly great dangers to personnel.



CAUTION

indicates instructions that must be followed precisely in order to avoid the possibility of slight injuries or damage to the meter or the environment.

Further notes



Note

indicates notes that draw your attention to special features.



Note

indicates cross-references to other documents, e.g. operating manuals.

Function and operational safety**2.1 Authorized use**

The authorized use of the meter consists exclusively of the measurement of the pH, ORP, conductivity and dissolved oxygen in a field and laboratory environment.

The technical specifications as given in chapter 7 TECHNICAL DATA must be observed. Only the operation and running of the meter according to the instructions given in this operating manual is authorized.

Any other use is considered **unauthorized**.

2.2 General safety instructions

This meter is constructed and tested in compliance with the IEC 1010 safety regulations for electronic measuring instruments.

It left the factory in a safe and secure technical condition.

The smooth functioning and operational safety of the meter can only be guaranteed if the generally applicable safety measures and the specific safety instructions in this operating manual are followed during operation.

The smooth functioning and operational safety of the meter can only be guaranteed under the environmental conditions that are specified in chapter 7 TECHNICAL DATA.

If the meter was transported from a cold environment to a warm environment, the formation of condensate can lead to the faulty functioning of the meter. In this event, wait until the temperature of the meter reaches room temperature before putting the meter back into operation.

CAUTION

The meter is only allowed to be opened by authorized personnel.



Safe operation

If safe operation is no longer possible, the meter must be taken out of service and secured against inadvertent operation!

Safe operation is no longer possible if the meter:

- has been damaged in transport
- has been stored under adverse conditions for a lengthy period of time
- is visibly damaged
- no longer operates as described in this manual.

If you are in any doubt, please contact the supplier of the meter.

Obligations of the purchaser

The purchaser of this meter must ensure that the following laws and guidelines are observed when using dangerous substances:

- EEC directives for protective labor legislation
- National protective labor legislation
- Safety regulations
- Safety datasheets of the chemical manufacturers.

**CAUTION**

In addition to the safety instructions mentioned here, also follow the safety instructions of the sensors used.

The operating manuals of the sensors are available on the supplied CD and on the Internet under www.WTW.com.

3 Commissioning

3.1 Scope of delivery

- pH meter Multi 3430
- 4 NiMH rechargeable batteries 1.2 V Mignon type AA
- USB cable (A plug on mini B plug)
- Power pack
- Short instructions
- Detailed operating manual (4 languages)
- CD-ROM

3.2 Power supply

The Multi 3430 is supplied with power in the following ways:

- Battery operation with NiMh rechargeable batteries
- Mains operation with the supplied power pack.
The NiMh rechargeable batteries are automatically charged while the power pack is connected.
- USB operation via a connected USB-B cable.
The inserted NiMh rechargeable batteries are not charged

3.3 Initial commissioning

Perform the following activities:

- Insert the rechargeable batteries and charge them
- Connect the power pack (mains operation / battery charging)
- Switch on the meter
- Set the date and time

3.3.1 Inserting the rechargeable batteries

1	Unscrew the two screws (1) on the underside of the meter.
2	Open the battery compartment (2) on the underside of the meter.

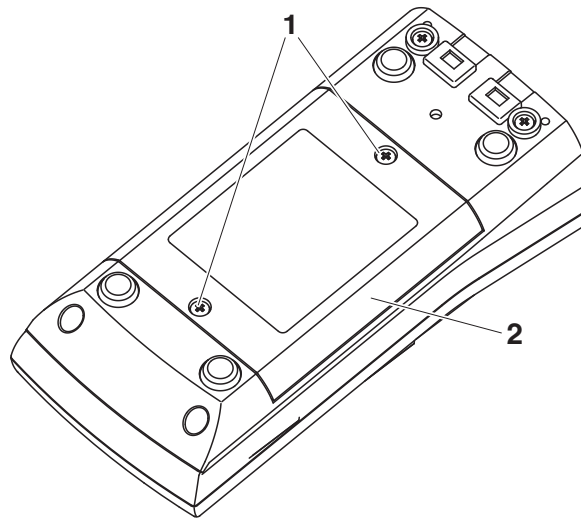

- 3 Place four rechargeable batteries (type Mignon AA) in the battery compartment.



CAUTION

Make sure that the poles of the rechargeable batteries are positioned correctly. The \pm signs on the batteries must correspond to the \pm signs in the battery compartment.

- 4 Close the battery compartment (2) and tighten the screws (1).

3.3.2 Connecting the power pack / charging the batteries



CAUTION

The line voltage at the operating site must lie within the input voltage range of the original power pack (see section 7.1).



CAUTION

Use original power packs only (see section 7.1).



CAUTION

The batteries in the battery compartment are automatically charged when the power pack is connected. Make sure that only NiMH rechargeable batteries are in the battery compartment. The charging process is optimized for NiMH rechargeable batteries. Other battery types can cause damage during the charging process.

1	Connect the plug of the power pack to the socket for the power pack on the Multi 3430.
2	Connect the original power pack to an easily accessible power outlet. The batteries are automatically charged in the background. You can continue to work with the Multi 3430 during the charging process. The  symbol is displayed.

**Note**

Charge the batteries completely prior to putting the meter into operation for the first time. The charging process takes approx. 10 hours. The  symbol is displayed if the batteries are nearly discharged.

3.3.3 Switching on the meter

1	Press the <On/Off> key. The meter performs a self-test. The display shows the manufacturer's logo while the self-test is being performed.
2	Connect the sensor. The meter switches to the measuring mode (measured value display).

**Note**

The meter has an energy saving feature to avoid unnecessary power consumption during battery operation. The energy saving feature switches off the meter during battery operation if no key is pressed during the adjusted interval. (How to set the switch-off interval, see section 4.3). The switch-off interval of the energy saving feature is not active when the meter is supplied with power via the power pack or the USB-B cable.

3.3.4 Setting the date and time

3	See section 4.2.5
---	-------------------

4 Operation

4.1 Switching on the meter

Switching on

Press the <On/Off> key.

The meter performs a self-test.

The display shows the manufacturer's logo while the self-test is being performed.

If a sensor is connected the measured value display appears.

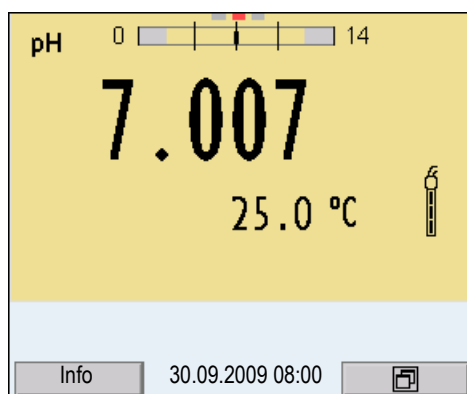

Switching off

Press the <On/Off> key.

Automatic switch-off

The instrument has an automatic switchoff function in order to save the batteries (see section 4.3.1). The automatic switchoff switches off the measuring instrument if no key is pressed for an adjustable period.

The automatic switchoff is not active

- if the power pack is connected
- if a USB-B cable is connected
- if the *Autom. storage* function is active, or with automatic data transmission

Display illumination

The meter automatically switches the display illumination to energy saving mode if no key is pressed for 20 seconds.

After a further 60 seconds, the meter switches off the display illumination completely.

The illumination is switched on with the next keystroke again.

You can also generally switch on the display illumination (see section 4.3.1).

4.2 General operating principles

This section contains basic information on the operation of the Multi 3430.

Operating elements, display

An overview of the operating elements and the display is given in section 1.1 and section 1.2.

Operating modes, navigation

An overview of the operating modes and navigation of the Multi 3430 is given in section 4.2.1 and section 4.2.3.

4.2.1 Operating modes

The meter has the following operating modes:

- Measuring
The measurement data of the connected sensors is shown in the measured value display
- Calibration
The course of a calibration with calibration information, functions and settings is displayed
- Storage in memory
The meter stores measuring data automatically or manually
- Data transmission
The meter transmits measuring data and calibration records to a USB-B interface automatically or manually.
- Setting
The system menu or a sensor menu with submenus, settings and functions is displayed

4.2.2 Display of several sensors in the measuring mode

The measured values of the connected sensors can be displayed in the following ways:

- Clear display of all connected sensors
- Detailed display of one sensor
(e.g. incl. CMC feature with pH sensors)

With the softkey you can very easily switch between the two display types. The suitable softkey is displayed depending on the operating situation.

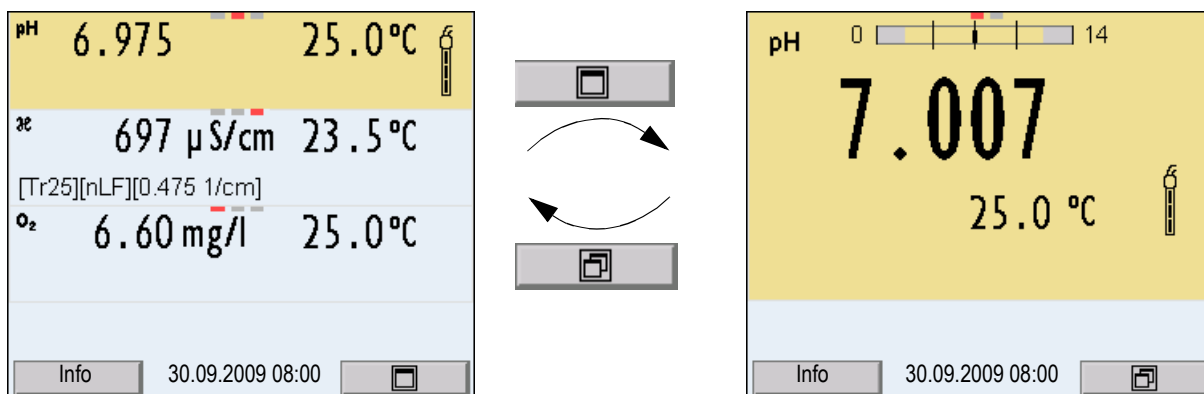

4.2.3 Navigation

Measured value display

In the measured value display, you can

- use <▲><▼> to select one of several connected sensors. The selected sensor is displayed with a colored background. The following actions / menus refer to the selected sensor
- open the menu for calibration and measurement settings with <MENU/ENTER> (short keystroke)
- open the *Storage & config* menu with the sensor-independent settings by pressing <MENU/ENTER __> (long keystroke, approx. 2 s).
- change the display in the selected measuring window (e. g. pH <-> mV) by pressing <M>.

Menus and dialogs

The menus for settings and dialogs in procedures contain further sub-menus. The selection is made with the <▲><▼> keys. The current selection is displayed with a frame.

- Submenus
The name of the submenu is displayed at the upper edge of the frame. Submenus are opened by confirming with <MENU/ENTER>. Example:

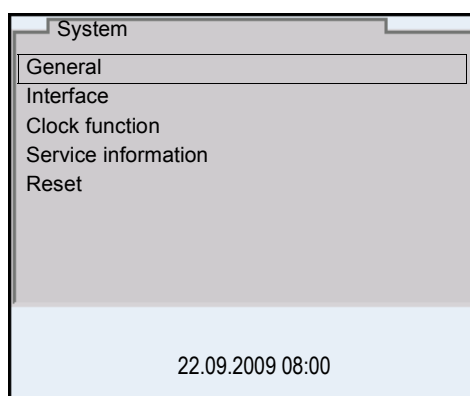

- Settings
Settings are indicated by a colon. The current setting is displayed on the right-hand side. The setting mode is opened with <MENU/ENTER>. Subsequently, the setting can be changed with <▲><▼> and <MENU/ENTER>. Example:

General	
Language:	Deutsch
Beep:	Off
Volume	9
Illumination:	On
Brightness:	12
Switchoff time:	1 h
Temperature unit	°C
Calibration data storage	On

22.09.2009 08:00

- **Functions**

Functions are designated by the name of the function. They are immediately carried out by confirming with **<MENU/ENTER>**. Example: Display the *Calibration record* function.

pH	
Calibration record	
Buffer:	TEC
One point calibration:	Yes
Calibration interval:	7 d
Unit for slope:	mV/pH
Calibration data storage	
[i] 2.00 4.01 7.00 10.01	

22.09.2009 08:00

Messages

Information is marked by the [i] symbol. They cannot be selected. Example:

pH	
Calibration record:	
Buffer:	TEC
One point calibration:	Yes
Calibration interval:	7 d
Unit for slope:	mV/pH
[i] 2.00 4.01 7.00 10.01	

22.09.2009 08:00



Note

The principles of navigation are explained in the two following sections by reference of examples:

- Setting the language (section 4.2.4)
- Setting the date and time (see section 4.2.5).

4.2.4 Example 1 on navigation: Setting the language

- 1 Press the **<On/Off>** key.
The measured value display appears.
The instrument is in the measuring mode.

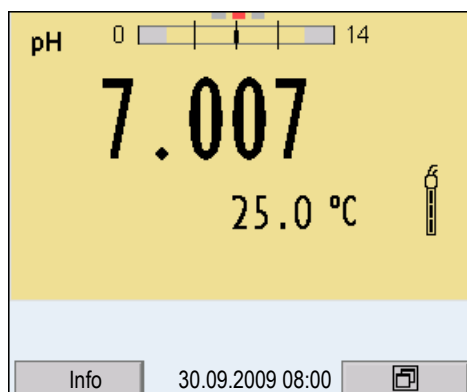

- 2 Open the *Storage & config* menu with **<MENU/ENTER__>**.
The instrument is in the setting mode.

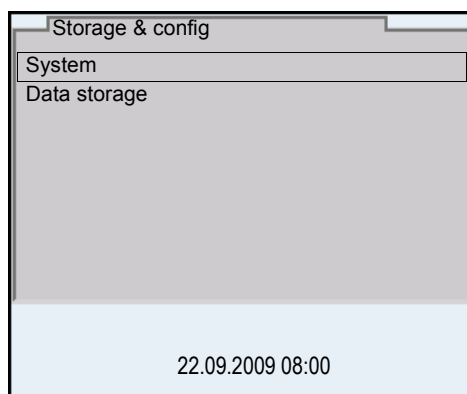

- 3 Select the *System* submenu with **<▲><▼>**.
The current selection is displayed with a frame.
- 4 Open the *System* submenu with **<MENU/ENTER>**.

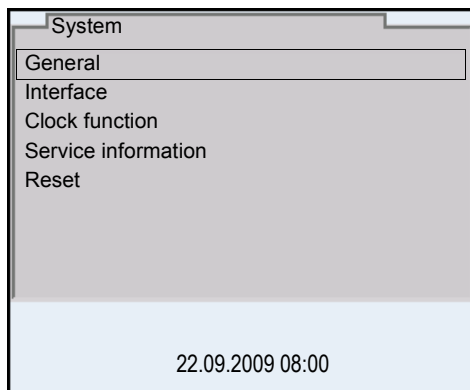

- 5 Select the *General* submenu with <▲><▼>. The current selection is displayed with a frame.
- 6 Open the *General* submenu with <MENU/ENTER>.

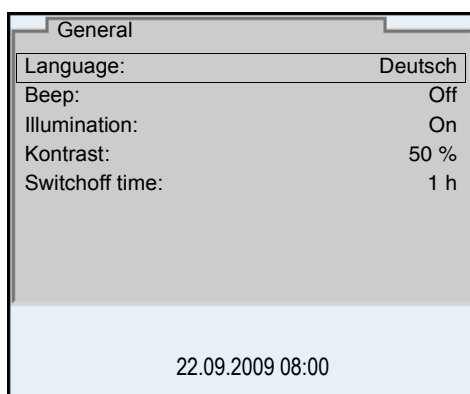

- 7 Open the setting mode for the *Language* with <MENU/ENTER>.

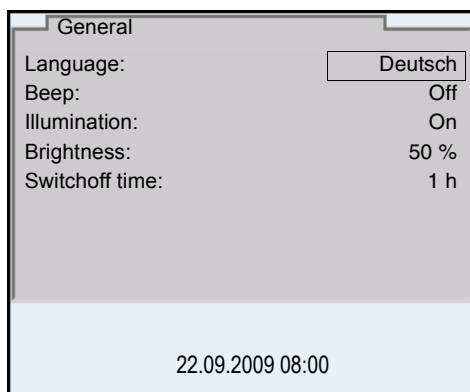

8	Select the required language with <▲><▼>.
9	Confirm the setting with <MENU/ENTER>. The meter switches to the measuring mode. The selected language is active.

4.2.5 Example 2 on navigation: Setting the date and time

The measuring instrument has a clock with a date function. The date and time are indicated in the status line of the measured value display. When storing measured values and calibrating, the current date and time are automatically stored as well.

The correct setting of the date and time and date format is important for the following functions and displays:

- Current date and time
- Calibration date
- Identification of stored measured values.

Therefore, check the time at regular intervals.



Note

After a fall of the supply voltage (empty batteries), the date and time are reset to 01.08.2009 00, 00:00 hours.

Setting the date, time and date format

The date format can be switched from the display of day, month, year (*dd.mm.yy*) to the display of month, day, year (*mm/dd/yy* or *mm.dd.yy*).

1	In the measured value display: Open the <i>Storage & config</i> menu with <MENU/ENTER__>. The instrument is in the setting operating mode.
2	Select and confirm the <i>System / Clock function</i> menu with <▲><▼> and <MENU/ENTER>. The setting menu for the date and time opens up.

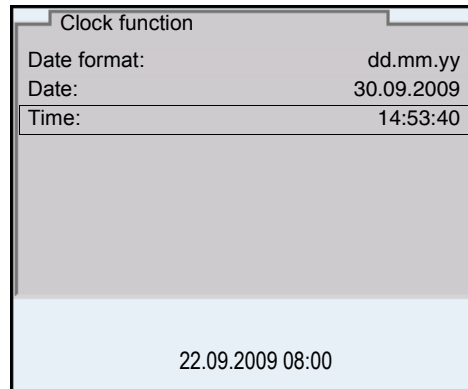

3	Select and confirm the <i>Time</i> menu with <▲><▼> and <MENU/ENTER> . The hours are highlighted.
4	Change and confirm the setting with <▲><▼> and <MENU/ENTER> . The minutes are highlighted.
5	Change and confirm the setting with <▲><▼> and <MENU/ENTER> . The seconds are highlighted.
6	Change and confirm the setting with <▲><▼> and <MENU/ENTER> . The time is set.
7	If necessary, set the <i>Date</i> and <i>Date format</i> . The setting is made similarly to that of the time.
8	If necessary, select and set the <i>Date</i> with <▲><▼> and <MENU/ENTER> .
9	To make further settings, switch to the next higher menu level with <ESC> . or Switch to the measured value display with <M> . The instrument is in the measuring operating mode.

4.3 Sensor-independent settings

The *Storage & config* menu includes the following settings:

- *System* (see section 4.3.1).
- *Data storage* (see section 4.3.2)

4.3.1 System

Overview

The following sensor-independent meter characteristics can be adjusted in the *Storage & config/System* menu:

- Menu language
- Beep on keystroke
- Loudness of the beep
- Illumination
- Brightness
- Interval of the automatic switchoff
- Data interface
- Clock and date function
- Reset of all sensor-independent system settings to the default condition

Settings

To open the *Storage & config* menu, press the **<MENU/ENTER__>** key in the measured value display. After completing the settings, switch to the measured value display with **<M>**.

Default settings are printed in **bold**.

Menu item	Setting	Description
<i>System / General / Language</i>	<i>Deutsch</i> English <i>(further)</i>	Selects the menu language
<i>System / General / Acoustic signal</i>	Beep 1 <i>Beep 2</i> <i>Off</i>	Selects/switches off the beep on keystroke
<i>System / General / Volume</i>	<i>0 ...</i> 5 <i>... 10</i>	Changes the loudness of the signal tone
<i>System / General / Illumination</i>	Auto <i>On</i>	Switches the display illumination on/off
<i>System / General / Brightness</i>	<i>0 ...</i> 10 <i>... 22</i>	Changes the display brightness
<i>System / General / Switchoff time</i>	<i>10 min ...</i> 1h <i>... 24 h</i>	Adjusts the switch-off time

Menu item	Setting	Description
<i>System / General / Temperature unit</i>	°C °F	Temperature unit, degrees Celsius or degrees Fahrenheit. All temperatures are displayed with the selected unit.
<i>System / General / Stability control</i>	On Off	Switches on or off the automatic stability control during measurement (see section 4.3.3)
<i>System / Interface / USB Host</i>	On Off	Switches on or off the USB Host interface. You can switch off the power supply of the USB Host interface to extend the operating time of the batteries. The USB Host interface has to be switched on in order to transfer data to a USB memory device.
<i>System / Interface / Baud rate</i>	1200, 2400, 4800 , 9600, 19200	Baud rate of the USB Device interface
<i>System / Interface / Output format</i>	ASCII CSV	Output format for data transmission For details, see section 4.10
<i>System / Interface / Decimal separator</i>	<i>Dot (xx.x)</i> <i>Comma (xx,x)</i>	Decimal separator
<i>System / Interface / Output header</i>		Output of a header for <i>Output format: CSV</i>
<i>System / Clock function</i>	<i>Date format</i> <i>Date</i> <i>Time</i>	Settings of time and date. For details, see section 4.2.5
<i>System / Service information</i>		Hardware version and software version of the meter are displayed.
<i>System / Reset</i>	-	Resets the system settings to the default values. For details, see section 4.11.2

4.3.2 Data storage

This menu contains all functions to display, edit and erase stored measured values.



Note

Detailed information on the storage functions of the Multi 3430 is given in section 4.9.

4.3.3 Automatic Stability control

The automatic *Stability control* (AutoRead) function continuously checks the stability of the measurement signal. The stability has a considerable impact on the reproducibility of measured values.

You can activate or switch off the automatic *Stability control* function (see section 4.6.3).

The measured parameter flashes on the display

- as soon as the measured value is outside the stability range
- when you switch over between the measured parameters with <M>.
- when the automatic *Stability control* is switched off.

4.4 Sensor info

You can display the current sensor data and sensor settings of a connected sensor at any time. The sensor data are available in the measured value display with the [Info] softkey.

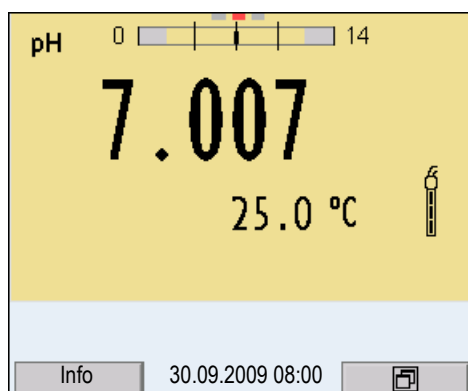

- 1 In the measured value display:
Display the sensor data (sensor name, series number) with [Info].

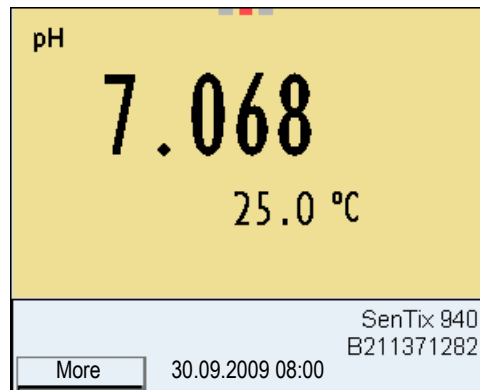

2 | Display further sensor data (settings) with [*More*].

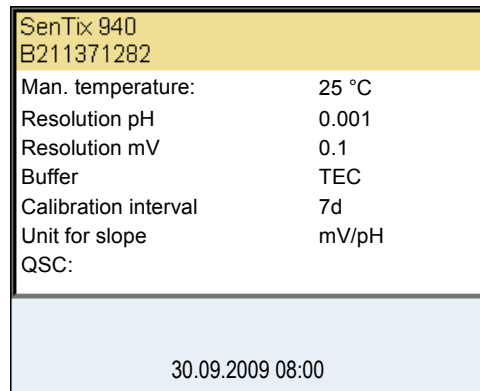

4.5 Channel display

The Multi 3430 manages the connected sensors and displays which sensor is plugged to which connection.

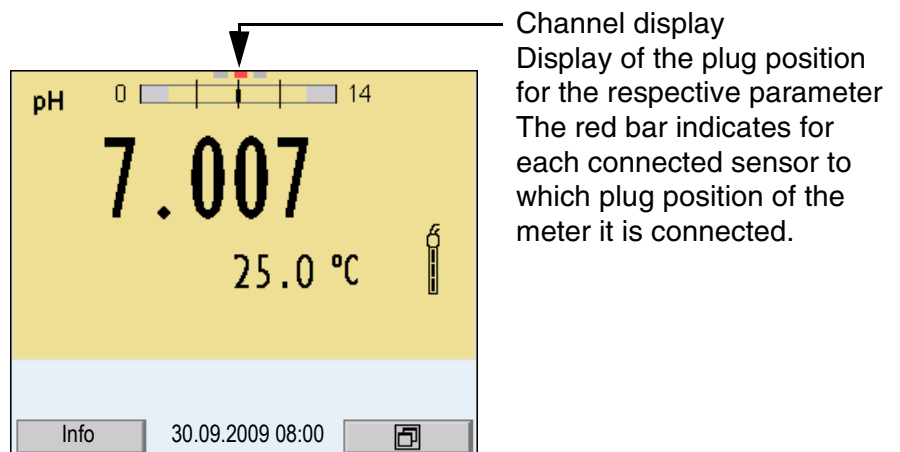

Channel display
 Display of the plug position for the respective parameter
 The red bar indicates for each connected sensor to which plug position of the meter it is connected.

4.6 pH value

4.6.1 General information

You can measure the following variables:

- pH value []
- Sensor voltage [mV]



Note

The sensor connection and the USB-B (device) interface are galvanically isolated. This facilitates interference-free measurements also in the following cases:

- Measurement in grounded test samples
- Measurement with several sensors connected to one Multi 3430 in one test sample

Temperature measurement

For reproducible pH measurements, it is essential to measure the temperature of the test sample. IDS sensors measure the temperature with a temperature sensor integrated in the IDS sensor.

Preparatory activities

Perform the following preparatory activities when you want to measure:

1	Connect the IDS pH sensor to the meter. The pH measuring window is displayed.
2	If necessary, select the measured parameter with <M>.
3	If necessary, calibrate or check the IDS pH sensor.

4.6.2 Measuring the pH value

- | | |
|---|--|
| 1 | Perform the preparatory activities according to section 4.6.1. |
| 2 | Immerse the IDS pH sensor in the test sample. |

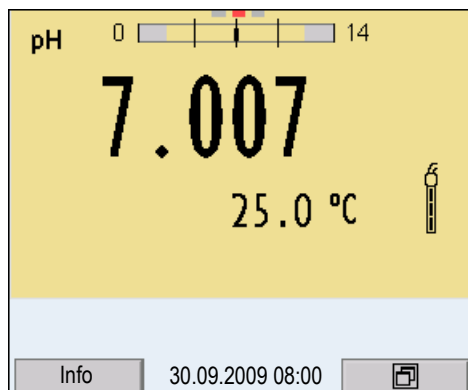

- | | |
|---|---|
| 3 | Select the pH or mV display with <M> . |
|---|---|

Stability control (AutoRead)

The stability control function (AutoRead) continually checks the stability of the measurement signal. The stability has a considerable impact on the reproducibility of measured values. The display of the measured parameter flashes until a stable measured value is available.

You can start the *Stability control* manually at any time, irrespective of the setting for automatic *Stability control* (see page 34) in the *Measurement* menu.

- | | |
|---|---|
| 1 | Freeze the measured value with <AR> .
The [HOLD] status indicator is displayed. |
| 2 | Using <MENU/ENTER> , activate the <i>Stability control</i> function manually.
The [AR] status indicator appears while the measured value is assessed as not stable. A progress bar is displayed and the display of the measured parameter flashes.
The [HOLD][AR] status indicator appears as soon as a stable measured value is recognized. The progress bar disappears and the display of the measured parameter stops flashing.
The current measurement data is output to the interface. Measurement data meeting the stability control criterion is marked by AR. |

**Note**

You can prematurely terminate the *Stability control* function manually with **<MENU/ENTER>** at any time. If the *Stability control* function is prematurely terminated, the current measurement data are output to the interface without the AutoRead info.

- | | |
|---|--|
| 3 | Release the frozen measured value again with <AR> or <M> . The [AR] status display disappears. The display switches back to the previous indication. |
|---|--|

Criteria for a stable measured value

The *Stability control* function checks whether the measured values are stable within the monitored time interval.

Measured parameter	Time interval	Stability in the time interval
pH value	15 seconds	Δ pH: Better than 0.01
Temperature	15 seconds	Δ T (° C): Better than 0.02

The minimum duration until a measured value is assessed as stable is the monitored time interval. The actual duration is mostly longer.

4.6.3 Settings for pH measurements

Overview The following settings are possible for pH measurements:

- Resolution
- *Calibration interval*
- Buffers for calibration
- Automatic stability control
- *Unit for slope*
- *Calibration record* (display)

Settings The settings are made in the menu for calibration and measurement settings of the pH/ORP measurement. To open the settings, display the required measured parameter in the measured value display and press the <MENU/ENTER> key. After completing the settings, switch to the measured value display with <M>. Default settings are printed in **bold**.

Menu item	Possible setting	Description
<i>Calibration / Calibration record</i>	-	Displays the calibration record of the last calibration.
<i>Calibration / Buffer</i>	TEC <i>NIST/DIN</i> <i>ConCal</i> ...	Buffer sets to be used for pH calibration. For further buffers and details, see section 4.6.4.
<i>Calibration / Single-point calibration</i>	<i>Yes</i> No	Quick calibration with 1 buffer
<i>Calibration / Calibration interval</i>	<i>1 ... 7 ... 999 d</i>	<i>Calibration interval</i> for the IDS pH sensor (in days). The meter reminds you to calibrate regularly by the flashing sensor symbol in the measuring window.
<i>Calibration / Unit for slope</i>	mV/pH %	Unit of the slope. The % display refers to the Nernst slope of -59.2 mV/pH (100 x determined slope/Nernst slope).
<i>Calibration / Calibration data storage</i>		Displays the last calibration records (max. 10)
<i>Man. temperature</i>	-25 ... +25 ... +130 °C	Entry of the manually determined temperature.

Menu item	Possible setting	Description
<i>pH resolution</i>	0.001 0.01 0.1	Resolution of the pH display
<i>mV resolution</i>	0.1 1	Resolution of the mV display
<i>Reset</i>	-	Resets all sensor settings to the delivery condition (see section 4.11.1).
<i>QSC /First calibration</i>		Starts the initial calibration with QSC buffers. This menu item is only available as long as no initial calibration was carried out with the connected IDS sensor.
<i>QSC /Record of first calibration</i>		Displays the calibration record of the QSC initial calibration.
<i>QSC /Control calibration</i>		Starts the control calibration with QSC buffers. This menu item is only available if an initial calibration was carried out with the connected IDS sensor.

4.6.4 pH calibration

Why calibrate?

IDS pH sensors age. This changes the zero point (asymmetry) and slope of the IDS pH sensor. As a result, an inexact measured value is displayed. Calibration determines the current values of the zero point and slope of the IDS pH sensor and stores them in the measuring instrument.

Thus, you should calibrate at regular intervals.

When do you have to calibrate?

- When the calibration interval has expired

Buffer sets for calibration

You can use the buffer sets quoted in the table for an automatic calibration. The pH values are valid for the specified temperature values. The temperature dependence of the pH values is taken into consideration during the calibration.

No.	Buffer set *	pH values	at
1	ConCal	Any	Any
2	NIST/DIN DIN buffers according to DIN 19266 and NIST Traceable Buffers	1.679 4.006 6.865 9.180 12.454	25 °C
3	TEC WTW Technical buffers	2.000 4.010 7.000 10.011	25 °C
4	Merck 1*	4.000 7.000 9.000	20°C
5	Merck 2 *	1.000 6.000 8.000 13.000	20°C
6	Merck 3 *	4.660 6.880 9.220	20°C
7	Merck 4 *	2.000 4.000 7.000 10.000	20°C

No.	Buffer set *	pH values	at
8	Merck 5 *	4.010 7.000 10.000	25 °C
9	DIN 19267	1.090 4.650 6.790 9.230	25 °C
10	Mettler Toledo US *	1.679 4.003 7.002 10.013	25 °C
11	Mettler Toledo EU *	1.995 4.005 7.002 9.208	25 °C
12	Fisher 1*	2.007 4.002 7.004 10.002	25 °C
13	Fluka BS *	4.006 6.984 8.957	25 °C
14	Radiometer *	1.678 4.005 7.000 9.180	25 °C
15	Baker *	4.006 6.991 10.008	25 °C
16	Metrohm *	3.996 7.003 8.999	25 °C
17	Beckman *	4.005 7.005 10.013	25 °C
18	Hamilton DC *	4.005 7.002 10.013	25 °C

No.	Buffer set *	pH values	at
8	Merck 5 *	4.010 7.000 10.000	25 °C
9	DIN 19267	1.090 4.650 6.790 9.230	25 °C
10	Mettler Toledo US *	1.679 4.003 7.002 10.013	25 °C
11	Mettler Toledo EU *	1.995 4.005 7.002 9.208	25 °C
12	Fisher 1*	2.007 4.002 7.004 10.002	25 °C
13	Fluka BS *	4.006 6.984 8.957	25 °C
14	Radiometer *	1.678 4.005 7.000 9.180	25 °C
15	Baker *	4.006 6.991 10.008	25 °C
16	Metrohm *	3.996 7.003 8.999	25 °C
17	Beckman *	4.005 7.005 10.013	25 °C
18	Hamilton DC *	4.005 7.002 10.013	25 °C

No.	Buffer set *	pH values	at
19	Precisa *	3.996 7.003 8.999	25 °C
20	Reagecon TEC *	2.000 4.010 7.000 10.000	25 °C
21	Reagecon 20 *	2.000 4.000 7.000 10.000 13.000	20°C
22	Reagecon 25 *	2.000 4.000 7.000 10.000 13.000	25 °C
23	Riedel-de Haen *	2.000 4.000 7.000 10.000	20°C

* Brand names or trade names are trademarks of their respective owners protected by law.



Note

The buffers are selected in the menu, pH / <MENU/ENTER> / Calibration / Buffer (see page 39).

Calibration points

Calibration can be performed using one to five buffer solutions in any order (single-point to five-point calibration). The meter determines the following values and calculates the calibration line as follows:

	Determined values	Displayed calibration data
1-point	<i>Asy</i>	<ul style="list-style-type: none"> ● Zero point = <i>Asy</i> ● Slope = Nernst slope (-59.2 mV/pH at 25 °C)
2-point	<i>Asy</i> <i>Slp.</i>	<ul style="list-style-type: none"> ● Zero point = <i>Asy</i> ● Slope = <i>Slp.</i>
3-point to 5-point	<i>Asy</i> <i>Slp.</i>	<ul style="list-style-type: none"> ● Zero point = <i>Asy</i> ● Slope = <i>Slp.</i> <p>The calibration line is calculated by linear regression.</p>

**Note**

You can display the slope in the units, mV/pH or % (see page 39).

Stability control

The calibration procedure automatically activates the stability control function. The current measurement with stability control can be terminated at any time (accepting the current value).

Calibration record

The new calibration values are displayed when a calibration procedure is completed.

Display calibration data and output to interface

You can have the data of the last calibration displayed (see page 54). Subsequently, you can transmit the displayed calibration data to the interface, e. g. to a PC, with the <PRT> key.

**Note**

The calibration record is automatically transmitted to the interface after calibrating.

Sample record

```

31.07.2009 15:55
Multi 3430
Ser. no. B211371282

CALIBRATIONpH
31.07.2009 16:13:33
SenTix 940
Ser. no. B211371282
AutoCal TEC
Buffer 1          4.01
Buffer 2          7.00
Buffer 3          10.01
Voltage 1         184.0 mV      24.0 °C
Voltage 2         3.0 mV       24.0 °C
Voltage 3        -177.0 mV      24.0 °C
Slope             -60.2 mV/pH
Asymmetry         4.0 mV
Sensor           +++

etc...
    
```

Calibration evaluation

After calibrating, the meter automatically evaluates the calibration. The zero point and slope are evaluated separately. The worse evaluation of both is taken into account. The evaluation appears on the display and in the calibration record.

Display	Calibration record	Zero point [mV]	Slope [mV/pH]
	+++	-15 ... +15	-60.5 ... -58
	++	-20 ... +20	-58 ... -57
	+	-25 ... +25	-61 ... -60.5 or -57 ... -56
	-	-30 ... +30	-62 ... -61 or -56 ... -50
Clean the IDS sensor according to the sensor operating manual			
<i>Error</i>	<i>Error</i>	< -30 or > 30	... -62 or ... -50
Eliminate the error according to chapter 6 WHAT TO DO IF...			



Note

For pH IDS sensors you can optionally enable a more finely graded calibration evaluation (QSC) (see section 4.6.10).

Preparatory activities

Perform the following preparatory activities when you want to calibrate:

1	Connect the IDS pH sensor to the meter. The pH measuring window is displayed.
2	Keep the buffer solutions ready.

4.6.5 Calibration interval

The calibration evaluation is displayed as a sensor symbol.

After the QSC function has been enabled the sensor symbol is replaced by the QSC color scale (see section 4.6.10).

After the specified calibration interval has expired the sensor symbol or the QSC color scale flashes. It is still possible to measure.

**Note**

To ensure the high measuring accuracy of the measuring system, calibrate after the calibration interval has expired.

Setting the calibration interval

The calibration interval is set to 7 days (d7) in the factory. You can change the interval (1 ... 999 days):

1	Open the menu for measurement settings with <MENU/ENTER> .
2	In the <i>Calibration / Calibration interval</i> menu, set the calibration interval with <▲><▼> .
3	Confirm the setting with <MENU/ENTER> .
4	Quit the menu with <M> .

4.6.6 Carrying out an automatic calibration (AutoCal)

Make sure that in the sensor menu, *Buffer* menu, the buffer set is correctly selected (see page 39).

Use any one to five buffer solutions of the selected buffer set in ascending or descending order.

Below, calibration with Technical buffers (TEC) is described. When other buffer sets are used, other nominal buffer values are displayed. Apart from that, the procedure is identical.



Note

If single-point calibration was set in the menu, the calibration procedure is automatically finished with the measurement of buffer solution 1 and the calibration record is displayed.

1	In the measured value display, select the measured parameter pH or mV with <M> .
2	Start the calibration with <CAL> . The calibration display appears.

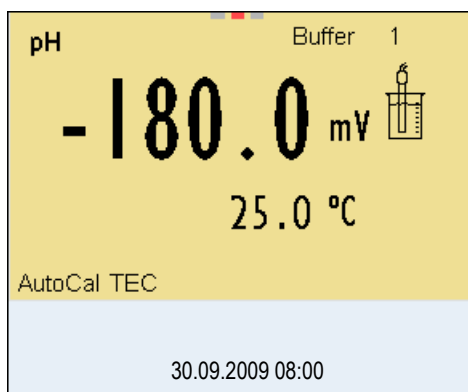

3	Immerse the IDS pH sensor in buffer solution 1.
4	Start the measurement with <MENU/ENTER> . The measured value is checked for stability (stability control). The [AR] status indicator is displayed. The measured parameter flashes.

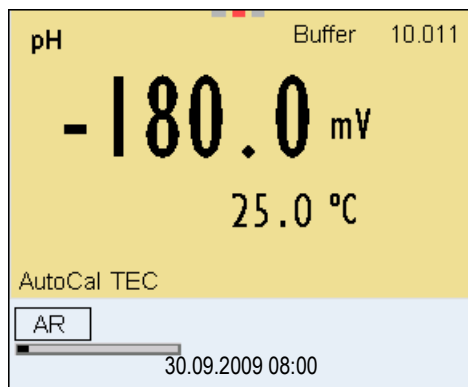

- 5 Wait for the end of the measurement with stability control or accept the calibration value with **<MENU/ENTER>**. The calibration display for the next buffer appears.

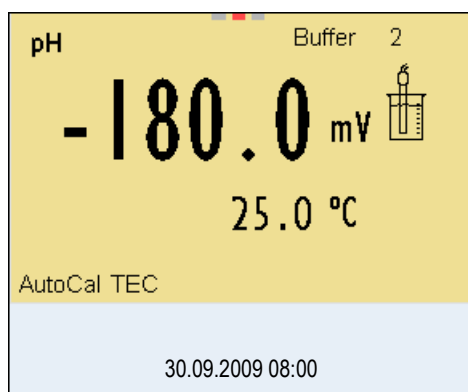

- 6 If necessary, finish the calibration procedure as a single-point calibration with **<M>**. The calibration record is displayed.



Note

For **single-point calibration**, the instrument uses the Nernst slope (-59.2 mV/pH at 25 °C) and determines the zero point of the IDS pH sensor.

Continuing with two-point calibration (*Buffer: TEC*)

- 7 Thoroughly rinse the IDS sensor with distilled water.
- 8 Immerse the IDS pH sensor in buffer solution 2.
- 9 Start the measurement with **<MENU/ENTER>**. The measured value is checked for stability (stability control). The [AR] status indicator is displayed. The measured parameter flashes.

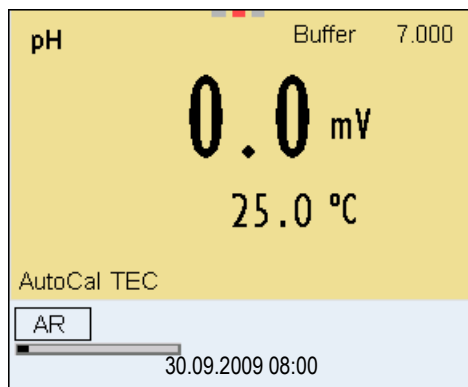

- 10 | Wait for the measurement with stability control to be completed or terminate the stability control and take over the calibration value with **<MENU/ENTER>**. The calibration display for the next buffer appears.

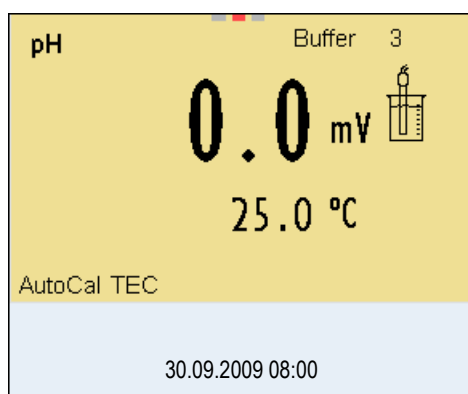

- 11 | Finish the calibration procedure as a two-point calibration with **<M>**. The calibration record is displayed.

Continuing with three-point to five-point calibration (Buffer TEC)

- 12 | Thoroughly rinse the IDS pH sensor with distilled water.
- 13 | Immerse the IDS pH sensor in buffer solution 3.
- 14 | Start the measurement with **<MENU/ENTER>**. The measured value is checked for stability (stability control). The [AR] status indicator is displayed. The measured parameter flashes.

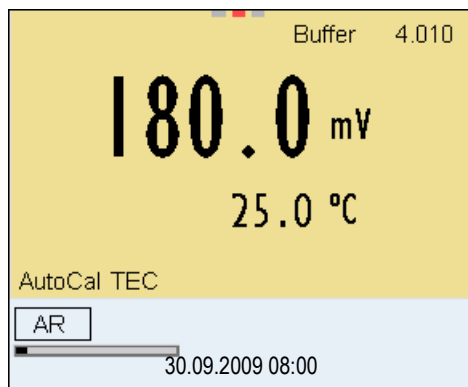

- 15 Use **<M>** to finish the calibration.
The calibration record is displayed.
or
Switch to calibration with the next buffer with **<MENU/ENTER>**.

**Note**

Calibration is automatically completed after the last buffer of a buffer set has been measured. Then the calibration record is displayed.

**Note**

The calibration line is determined by linear regression.

4.6.7 Carrying out a manual calibration (ConCal)

Single-point calibration

Use any buffer solution for this rapid method.
The calibration will be the more exact the nearer the pH value of the buffer solution is to that of the test sample.

Two-point calibration

Use two buffer solutions for this procedure:

- first buffer solution: pH 7.0 ± 0.5
- any other buffer solution

To carry out this procedure, *ConCal* has to be set as the buffer set (see section 4.6.3) in the *Buffer* menu of the sensor menu.



Note

If single-point calibration was set in the menu, the calibration procedure is automatically finished with the measurement of buffer solution 1 and the calibration record is displayed.

1	In the measured value display, select the measured parameter pH or mV with <M> .
2	Start the calibration with <CAL> . The calibration display appears.

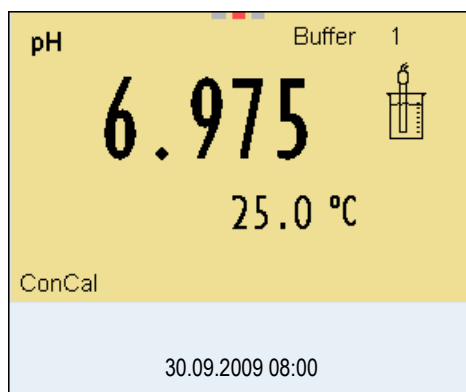

3	Thoroughly rinse the IDS pH sensor with distilled water.
4	Immerse the IDS pH sensor in buffer solution 1.
5	Start the measurement with <MENU/ENTER> . The measured value is checked for stability (stability control). The measured parameter flashes.

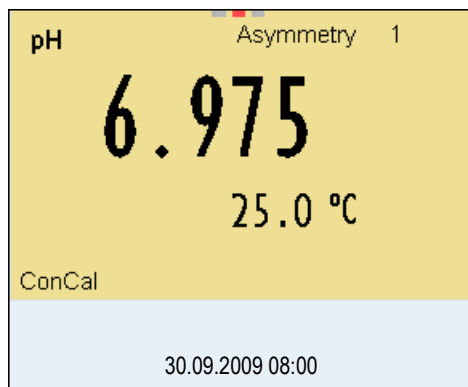

- | | |
|---|--|
| 6 | Wait for the measurement with stability control to be completed.
Set the nominal buffer value for the measured temperature with <▲><▼>. |
| 7 | Take over the calibration value for the asymmetry with <MENU/ENTER>.
The calibration display for the next buffer appears. |

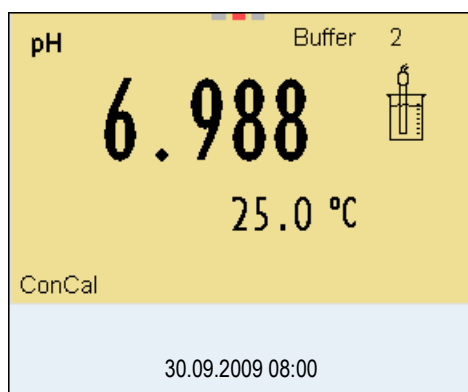

- | | |
|---|--|
| 8 | If necessary, finish the calibration procedure as a single-point calibration with <M>.
The calibration record is displayed. |
|---|--|

**Note**

For **single-point calibration**, the instrument uses the Nernst slope (-59.2 mV/pH at 25 °C) and determines the zero point of the IDS pH sensor.

Continuing with two-point calibration

9	Thoroughly rinse the IDS pH sensor with distilled water.
10	Immerse the IDS pH sensor in buffer solution 2.
11	Start the measurement with <MENU/ENTER> . The measured value is checked for stability (stability control). The measured parameter flashes.
12	Wait for the measurement with stability control to be completed. Set the nominal buffer value for the measured temperature with <▲><▼> .

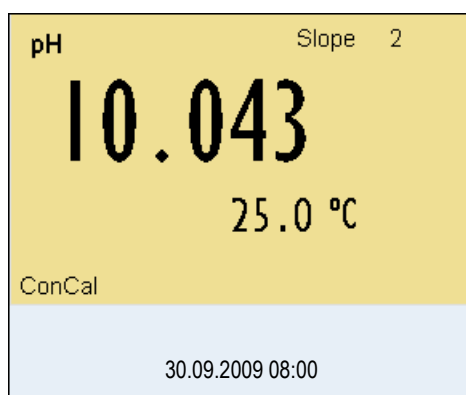

13	Take over the calibration value for the slope with <MENU/ENTER> . The calibration is completed as a two-point calibration. The calibration record is displayed.
----	--

4.6.8 Displaying calibration records

Displaying the calibration record

The calibration data can be displayed and then output to the interface.

The calibration record of the last calibration is to be found under the menu item, *Calibration / Calibration record*. To open it in the measured value display, press the **<CAL__>** key.

The calibration records of the last 10 calibrations are to be found in the menu, *Calibration / Calibration data storage*. To open the *Calibration* menu, press the **<MENU/ENTER>** key in the measured value display.

Menu item	Setting/function	Description
<i>Calibration / Calibration data storage</i>	-	<p>Displays the calibration records.</p> <p><u>Further options:</u></p> <ul style="list-style-type: none"> ● Scroll through the calibration records with <<<>>>. ● Output the displayed calibration record to the interface with <PRT>. ● Output all calibration records to the interface with <PRT__>. ● Quit the display with <ESC> or <MENU/ENTER>. ● Switch directly to the measured value display with <M>.

Sample printout

```

31.07.2009 16:55
Multi 3430
Ser. no. 08502113

CALIBRATIONpH
SenTix 940
Ser. no. B211371282
31.07.2009 16:13:33
AutoCal TEC
Buffer 1          4.01
Buffer 2          7.00
Buffer 3          10.01
Voltage 1         184.0 mV    24.0 °C
Voltage 2         3.0 mV      24.0 °C
Voltage 3        -177.0 mV    24.0 °C
Slope            -60.2 mV/pH
Asymmetry        4.0 mV
Sensor           +++

etc...
```

4.6.9 Continuous measurement control (CMC function)

The Continuous Measurement Control (CMC function) facilitates to evaluate the current measured value instantly and definitely.

After each successful calibration the scale of the pH measuring range is displayed in the measured value display. Here you can very clearly see whether or not the current measured value is in the calibrated part of the measuring range.

The following information is displayed:

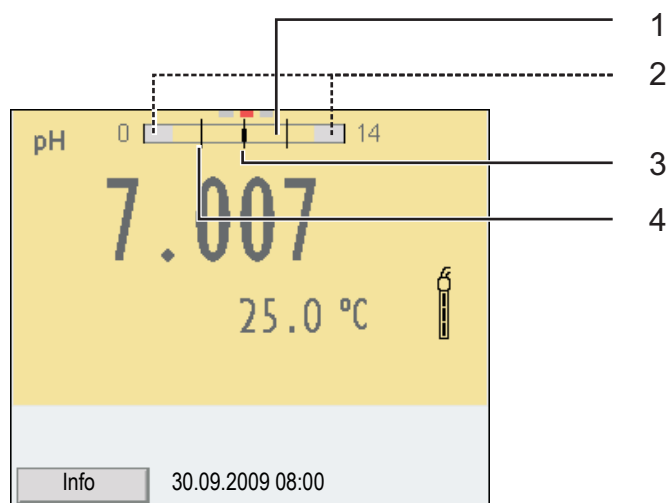

- | | |
|----------|---|
| 1 | Measuring range for which a valid calibration is available (background color). Measured values in this range are suitable for documentation. |
| 2 | Measuring range for which no valid calibration is available (light gray). Measured values in this range are not suitable for documentation. Calibrate the meter with buffers covering this measuring range.
If the current measured value is not in the calibrated range, the color of this range changes to dark gray.
If a measured value is outside the measuring range pH 0 - 14, overflow arrows are displayed at the left or right edge of the measuring range. |
| 3 | Currently measured pH value (needle) |
| 4 | Marking lines for all nominal buffer values used with the last valid calibration |

The limits of the calibrated range are determined by the buffers used for calibration:

Lower limit:	Buffer with lowest pH value - 2 pH units
Upper limit:	Buffer with highest pH value + 2 pH units

4.6.10 QSC function (sensor quality control)

General information on the QSC function

The QSC function (Quality Sensor Control) is a new sensor evaluation for digital IDS sensors. It evaluates the condition of an IDS pH sensor individually and with a very fine grading.

On the display, the QSC color scale (from green to yellow) indicates the current sensor evaluation by means of a pointer.

The sensor evaluation is documented as a percentage (1 - 100) both in the calibration record and for individual measurement datasets.

The finely graded sensor evaluation of the QSC function promptly calls your attention to changes of the sensor.

Thus you can do what is necessary to restore the optimum measuring quality (e.g. clean, calibrate or replace the sensor).

Sensor evaluation with / without QSC function

With QSC function	Without QSC function (sensor symbol)
Very fine grading of the sensor evaluation (100 grades)	Rough grading of the sensor evaluation (4 grades)
The reference value is individually determined for each sensor during the QSC initial calibration.	A theoretical reference value is used for all sensors
Low tolerances for zero point and slope when using QSC buffer solutions	Greater tolerances for zero point and slope when using commercial buffer sets
Additional QSC calibration required (with special QSC buffer set)	No additional calibration required

QSC calibration

The QSC function is enabled by once carrying out an additional three-point calibration with special QSC buffer solutions. It covers the entire measuring range of the sensor. The QSC initial calibration determines the actual condition of the sensor and stores it as a reference in the sensor.

To meet the high requirements of a QSC initial calibration, the QSC initial calibration should optimally be carried out with the initial commissioning of the sensor.

Carry out the normal calibrations for your special measuring range with your usual standard solutions as previously done.

**Note**

As soon as the QSC function was enabled for an IDS sensor, it is not possible to return to the sensor evaluation with the sensor symbol for this sensor.

Carrying out a QSC initial calibration

- | | |
|---|---|
| 1 | Open the menu for measurement settings with <MENU/ENTER> . |
| 2 | In the <i>QSC</i> menu, select <i>First calibration</i> with <▲><▼> . The calibration display appears. <i>AutoCal QSC-Kit</i> is displayed as the buffer. Exclusively use the QSC-Kit for the QSC calibration. If you use other buffers, you will have no valid QSC calibration. |

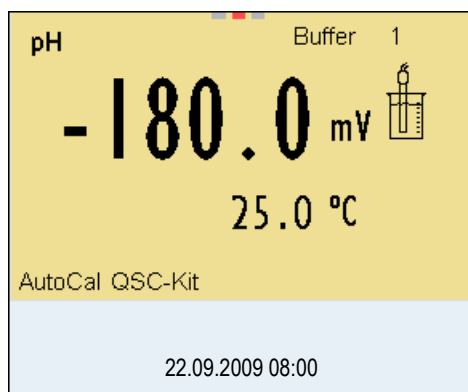

- | | |
|---|---|
| 3 | Calibration with the buffers of the QSC-Kit is done like a normal three-point calibration. Follow the user guide. |
|---|---|

**Note**

Carry out the QSC initial calibration very carefully. It determines the reference value for the sensor. This reference value cannot be overwritten or reset.

As soon as the QSC function was enabled, it is not possible to return to the sensor evaluation with the sensor symbol.

- 4 | As soon as the three-point calibration has been successfully carried out you can decide whether to accept or discard the calibration as the QSC initial calibration.

The QSC initial calibration is completed. The sensor is calibrated. If you want to calibrate with special buffers for your measurements, you can subsequently carry out a normal calibration with your buffers. The reference values determined with the QSC calibration are also used for the evaluation of normal calibrations. In the measured value display, the color scale of the QSC function is always displayed. A double arrow on the color scale indicates the current sensor evaluation.

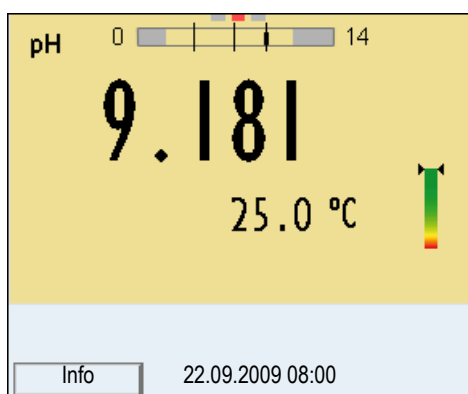

← **QSC color scale**

The double arrow on the color scale indicates the current sensor evaluation.

You can carry out QSC control calibrations at greater intervals than normal calibrations. A QSC control calibration can, e.g. be useful if the sensor evaluation noticeably changed (after some normal calibrations).

Carrying out a QSC control calibration

- 1 | Open the menu for measurement settings with **<MENU/ENTER>**.
- 2 | In the QSC menu, select *Control calibration* with **<▲><▼>**. The calibration display appears. *AutoCal QSC-Kit* is displayed as the buffer. Exclusively use the QSC-Kit for the QSC calibration. If you use other buffers, you will have no valid QSC control calibration.
- 3 | Follow the user guide. The calibration is carried out like a normal three-point calibration. As soon as the three-point calibration has been successfully carried out you can decide whether to accept or discard the calibration as the QSC control calibration.

4.7 ORP voltage

4.7.1 General information

You can measure the following variables:

- ORP [mV]



Note

The sensor connection and the USB-B (device) interface are galvanically isolated. This facilitates interference-free measurements also in the following cases:

- Measurement in grounded test samples
- Measurement with several sensors connected to one Multi 3430 in one test sample

Preparatory activities

Perform the following preparatory activities when you want to measure:

1	Connect the IDS ORP sensor to the meter. The ORP measuring window is displayed.
2	Check the meter with the IDS ORP sensor.

4.7.2 Measuring the ORP



Note

IDS ORP sensors are not calibrated. However, you can check IDS ORP sensors using a test solution.

1	Perform the preparatory activities according to section 4.6.1.
2	Immerse the IDS ORP sensor in the test sample.

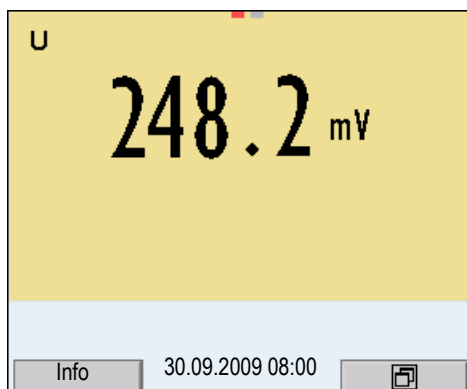

- 3 Select the mV display with <M>.

Stability control (AutoRead)

The stability control function (AutoRead) continually checks the stability of the measurement signal. The stability has a considerable impact on the reproducibility of measured values. The display of the measured parameter flashes until a stable measured value is available.

You can start the *Stability control* manually at any time, irrespective of the setting for automatic *Stability control* (see page 34) in the *System* menu.

- 1 Freeze the measured value with <AR>. The [HOLD] status indicator is displayed.
- 2 Using <MENU/ENTER>, activate the *Stability control* function manually.
The [AR] status indicator appears while the measured value is assessed as not stable. A progress bar is displayed and the display of the measured parameter flashes.
The [HOLD][AR] status indicator appears as soon as a stable measured value is recognized. The progress bar disappears and the display of the measured parameter stops flashing.
The current measurement data is output to the interface. Measurement data meeting the stability control criterion is marked by AR.



Note

You can prematurely terminate the *Stability control* function manually with <MENU/ENTER> at any time. If the *Stability control* function is prematurely terminated, the current measurement data are not output to the interface.

- 3 Release the frozen measured value again with <AR> or <M>. The [AR] status display disappears. The display switches back to the previous indication.

Criteria for a stable measured value

The *Stability control* function checks whether the measured values are stable within the monitored time interval.

Measured parameter	Time interval	Stability in the time interval
ORP voltage	15 seconds	Δ mV: Better than 0.3

The minimum duration until a measured value is assessed as stable is the monitored time interval. The actual duration is mostly longer.

4.7.3 Settings for ORP measurements

Overview The following settings are possible for ORP measurements:

- Resolution
- Automatic stability control

Settings The settings are made in the menu for measuring settings of the ORP measurement. To open the settings, display the required measured parameter in the measured value display and press the **<MENU/ENTER>** key. After completing the settings, switch to the measured value display with **<M>**. Default settings are printed in **bold**.

Menu item	Possible setting	Description
<i>mV resolution</i>	0.1 1	Resolution of the mV display
<i>Reset</i>	-	Resets all sensor settings to the delivery condition (see section 4.11.1).

4.8 Conductivity

4.8.1 General information

You can measure the following variables:

- Conductivity
- Specific resistance
- Salinity
- Total dissolved solids (TDS)

Temperature measurement Preparatory activities

IDS sensors measure the temperature with a temperature sensor integrated in the IDS sensor.

Perform the following preparatory activities when you want to measure:

- | | |
|---|--|
| 1 | Connect an IDS conductivity sensor to the meter. The conductivity measuring window is displayed. The <i>Measuring cell</i> and cell constant for the connected IDS conductivity sensor are automatically taken over. |
|---|--|

4.8.2 Measuring

You can carry out conductivity measurements as follows:

- | | |
|---|--|
| 1 | Perform the preparatory activities according to section 4.8.1. |
| 2 | Immerse the IDS conductivity sensor in the test sample. |

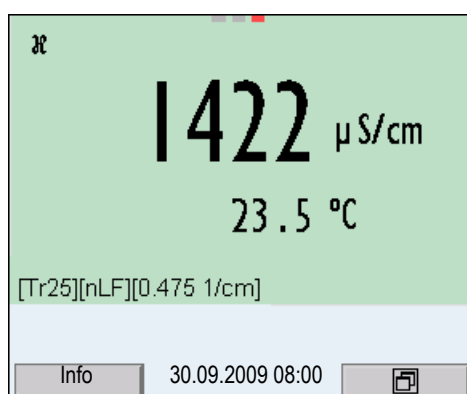

Selecting the displayed measured parameter

You can switch between the following displays with **<M>**:

- Conductivity [$\mu\text{S}/\text{cm}$] / [mS/cm]
- Resistivity [$\Omega\cdot\text{cm}$] / [$\text{k}\Omega\cdot\text{cm}$] / [$\text{M}\Omega\cdot\text{cm}$]
- Salinity SaL []
- Total dissolved solids TDS [mg/l] / [g/l]

The factor to calculate the total dissolved solids is set to 1.00 in the factory. You can adjust this factor to meet your requirements in the range of 0.40 to 1.00. The factor is set in the *Measurement* menu for the parameter, TDS.

Freezing the measured value (HOLD function)

With the HOLD function, you can freeze the current measured value. The displayed measured value stops changing until you switch the HOLD function off.

- 1 Freeze the measured value with **<AR>**.
The [HOLD] status indicator is displayed.



Note

If the HOLD function is active, you can, e.g. start a manual measurement with stability control.

- 2 Release the frozen measured value again with **<AR>**.
The HOLD function is switched off.
The [HOLD] status display disappears.

Stability control (AutoRead)

The stability control function (AutoRead) continually checks the stability of the measurement signal. The stability has a considerable impact on the reproducibility of measured values. The display of the measured parameter flashes until a stable measured value is available.

You can start the *Stability control* manually at any time, irrespective of the setting for automatic *Stability control* (see page 34) in the *Measurement* menu.

- 1 Freeze the measured value with **<AR>**.
The [HOLD] status indicator is displayed.

- 2 Using <MENU/ENTER>, activate the *Stability control* function manually.
 The [AR] status indicator appears while the measured value is assessed as not stable. A progress bar is displayed and the display of the measured parameter flashes.
 The [HOLD][AR] status indicator appears as soon as a stable measured value is recognized. The progress bar disappears and the display of the measured parameter stops flashing.
 The current measurement data is output to the interface. Measurement data meeting the stability control criterion is marked by AR.



Note

You can prematurely terminate the *Stability control* function manually with <MENU/ENTER> at any time. If the *Stability control* function is prematurely terminated, the current measurement data are not output to the interface.

- 3 Using <MENU/ENTER>, start a further measurement with *Stability control*.
 or
 Release the frozen measured value again with <AR>.
 The display switches to the measured value display.
 The [AR][HOLD] status display disappears.

Criteria for a stable measured value

The *Stability control* function checks whether the measured values are stable within the monitored time interval.

Measured parameter	Time interval	Stability in the time interval
Conductivity \varnothing	10 seconds	$\Delta \varnothing$: better than 0.5% of measured value
Temperature	10 seconds	ΔT (° C): Better than 0.02

The minimum duration until a measured value is assessed as stable is the monitored time interval. The actual duration is mostly longer.

4.8.3 Temperature compensation

The calculation of the temperature compensation is based on the pre-set reference temperature, 20 °C or 25 °C. It appears on the display as *Tr20* or *Tr25*.

You can select one of the following temperature compensation methods:

- **Nonlinear temperature compensation (*nLF*)** according to EN 27 888
- **Linear temperature compensation (*lin*)** with adjustable coefficients of 0.000 ... 3.000 %/K
- No temperature compensation (off)



Note

The reference temperature and temperature compensation are set in the *Measurement* menu for the parameter, conductivity (see section 4.8.4).

Application tips

Select the following temperature compensations given in the table according to the respective test sample:

Test sample	Temperature compensation	Display indicator
Natural water (ground water, surface water, drinking water)	<i>nLF</i> according to EN 27 888	<i>nLF</i>
Ultrapure water	<i>nLF</i> according to EN 27 888	<i>nLF</i>
Other aqueous solutions	<i>lin</i> Set linear temperature coefficient 0.001 ... 3.000 %/K	<i>lin</i>
Salinity (seawater)	Automatic <i>nLF</i> according to IOT	<i>Sal, nLF</i>

4.8.4 Settings for IDS conductivity sensors

Overview

The following settings are possible for IDS conductivity sensors:

- *Calibration record* (display)
- *Calibration interval*
- Reference temperature
- Temperature compensation
- TDS factor
- Unit of the temperature
- Automatic *Stability control*

Settings

The settings are made in the *Measurement* menu for the measured parameter, conductivity. To open the settings, display the required measured parameter in the measured value display and press the **<MENU/ENTER>** key. After completing the settings, switch to the measured value display with **<M>**.

The possible settings are individually displayed for each sensor. Below the setting menu is displayed for two IDS sensors (TetraCon 925, LR325/01).

Default settings are printed in **bold**.

Setting menu of TetraCon 925

Menu item	Possible setting	Description
<i>Calibration / Calibration record</i>	-	Displays the calibration record of the last calibration.
<i>Calibration / Calibration interval</i>	1 ... 150 ... 999 d	<i>Calibration interval</i> for the IDS conductivity sensor (in days). The meter reminds you to calibrate regularly by the flashing sensor symbol in the measuring window.
<i>Measurement / Measuring cell / Type</i>	cal man	<i>Measuring cell</i> used Measuring cells whose cell constant is determined by calibration in the KCL control standard solution. Calibration range: 0.450 to 0.500 cm ⁻¹ The currently valid cell constant is displayed in the status line. Freely adjustable cell constant in the range 0.450 ... 0.500 cm ⁻¹ .

Menu item	Possible setting	Description
<i>Measurement / Measuring cell / Man. cell const.</i>	0.450 ... 0.475 ... 0.500 cm ⁻¹	Display and setting option of the cell constant of any measuring cells (<i>man</i>).
<i>Measurement / Temp. comp. (TC) / Method</i>	nLF <i>lin</i> <i>Off</i>	Procedure for temperature compensation (see section 4.8.3). This setting is only available for the measured parameters, æ and ρ .
<i>Measurement / Temp. comp. (TC) / Linear coeff.</i>	0.000 ... 2.000 ... 3.000 %/K	Coefficient of the linear temperature compensation. This setting is only available when the linear temperature compensation is set.
<i>Measurement / Temp. comp. (TC) / Reference temp.</i>	20 °C 25 °C	Reference temperature This setting is only available for the measured parameters, æ and ρ .
<i>Measurement / TDS factor</i>	0.40 ... 1.00	Factor for TDS value
<i>Reset</i>	-	Resets all sensor settings to the delivery condition (see section 4.11.1).

Setting menu of
LR325/01

Menu item	Possible setting	Description
<i>Measurement / Measuring cell / Cell constant</i>	0.090 0.100 ... 0.110 cm ⁻¹	Display and setting option of the cell constant of any measuring cells (<i>man</i>).
<i>Measurement / Temp. comp. (TC) / Method</i>	nLF <i>lin</i> <i>Off</i>	Procedure for temperature compensation (see section 4.8.3). This setting is only available for the measured parameters, æ and ρ .
<i>Measurement / Temp. comp. (TC) / Linear coeff.</i>	0.000 ... 2.000 ... 3.000 %/K	Coefficient of the linear temperature compensation. This setting is only available when the linear temperature compensation is set.
<i>Measurement / Temp. comp. (TC) / Reference temp.</i>	20 °C 25 °C	Reference temperature This setting is only available for the measured parameters, æ and ρ .
<i>Measurement / TDS factor</i>	0.40 ... 1.00	Factor for TDS value
<i>Reset</i>	-	Resets all sensor settings to the delivery condition (see section 4.11.1).

4.8.5 Determining the cell constant (calibration in control standard)

Why determine the cell constant?

Aging slightly changes the cell constant, e. g. due to coatings. As a result, an inexact measured value is displayed. The original characteristics of the cell can often be restored by cleaning the cell. Calibration determines the current value of the cell constant and stores this value in the meter.

Thus, you should calibrate at regular intervals (we recommend: every 6 months).

Procedure

You can determine the actual cell constant of the IDS conductivity sensor cell by calibrating with the control standard in the following range:

- 0.450 ... 0.500 cm⁻¹
(e.g. TetraCon 925, nominal cell constant 0.475)

The cell constant is determined in the control standard, 0.01 mol/l KCl.

In the delivery condition, the calibrated cell constant of the IDS sensor is set to 0.475 cm⁻¹ (conductivity measuring cell, TetraCon 925).

Stability control (AutoRead)

In calibration, the Stability control function (AutoRead) is automatically activated.

Display calibration data and output to interface

You can have the data of the last calibration displayed (see section 4.8.6). Subsequently, you can transmit the displayed calibration data to the interface, e. g. to a printer or PC, with the <PRT> key.



Note

The calibration record is automatically transmitted to the interface after calibrating.

Sample record:

```
31.07.2009 16:55:12
Multi 3430
Ser. no. 09507128

CALIBRATION Cond
TetraCon 925
Ser. no. B211371282
31.07.2009 16:13:33

Cell constant 0.836 1/cm      25.0 °C
Sensor                      +++
```

Calibration evaluation

After the calibration, the meter automatically evaluates the current status of the calibration. The evaluation appears on the display and in the calibration record.

Display	Calibration record	Cell constant [cm^{-1}]
	+++	Within the range 0.450 ... 0.500 cm^{-1}
<i>Error</i> Eliminate the error according to chapter 6 WHAT TO DO IF...	<i>Error</i>	Outside the range 0.450 ... 0.500 cm^{-1}

Determining the cell constant

For this calibration procedure, the *Measuring cell* setting must be set to *cal* in the *Measurement* menu. Proceed as follows to determine the cell constant:

1	Connect an IDS conductivity sensor to the meter.
2	In the measured value display, select the conductivity parameter with <M> .
3	Start the calibration with <CAL> . The cell constant that was calibrated last is displayed.

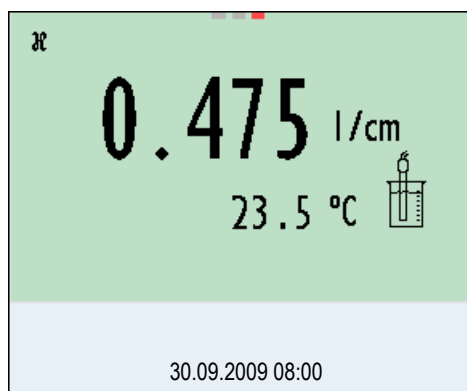

4	Immerse the IDS conductivity sensor in the control standard solution, 0.01 mol/l KCl.
5	Start the measurement with <MENU/ENTER> . The measured value is checked for stability (stability control). The [AR] status indicator is displayed. The measured parameter flashes.

6	Wait for the end of the measurement with stability control or accept the calibration value with <MENU/ENTER> . The calibration record is displayed and output to the interface.
7	Switch to the measured value display with <MENU/ENTER> .

Displaying the calibration record

4.8.6 Displaying calibration records

The calibration data can be displayed and then output to the interface.

The calibration record of the last calibration is to be found under the menu item, *Calibration / Calibration record*. To open it in the measured value display, press the **<CAL__>** key.

The calibration records of the last 10 calibrations are to be found in the menu, *Calibration / Calibration data storage*. To open the *Calibration* menu, press the **<MENU/ENTER>** key in the measured value display.

4.9 Data storage

You can transmit measured values (datasets) to the data storage:

- Manual storage (see section 4.9.1)
- Automatic storage at intervals (see section 4.9.2)

Each storage process transmits the current dataset to the interface at the same time.

Measurement dataset

A complete dataset consists of:

- Date/time
- Meter name, series number
- Sensor name, series number
- ID number
- Measured value of the connected sensor
- Measured temperature value of the connected sensor
- AutoRead info: *AR* appears with the measured value if the Auto-Read criterion was met while storing (stable measured value). Otherwise, the *AR* display is missing.
- Calibration evaluation:
 - 4 levels (+++, ++, +, -, or no evaluation) or
 - QSC (percentage)

Storage locations

The Multi 3430 meter has two measurement data memories. The measured values recorded either manually or automatic are stored separately in individual measurement data memories.

Storage	Maximum number of datasets
<i>Manual data storage</i>	200
<i>Automatic data storage</i>	5000

4.9.1 Manual storage

You can transmit a measurement dataset to the data storage as follows. The dataset is at the same time output to the interface:

- 1 Press the **<STO>** key shortly.
The menu for manual storage appears.

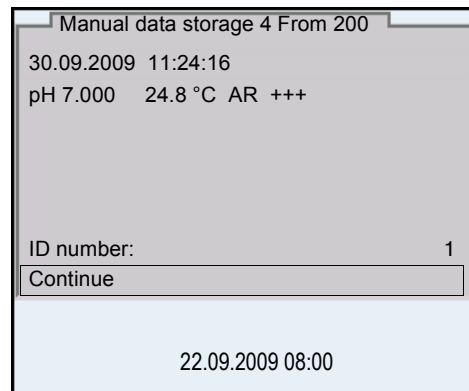

- 2 If necessary, change and confirm the ID number (1 ... 10000) with **<▲><▼>** and **<MENU/ENTER>**.
The dataset is stored. The meter switches to the measured value display.

If the storage is full

When all memory locations are occupied, it is not possible to continue storing. Then you can e.g. transmit the stored data to a PC or a USB flash drive (see section 4.9.3) and subsequently erase the storage (see section 4.9.4).

4.9.2 Automatic storage at intervals

The storage interval (*Interval*) determines the time interval between automatic storage processes. Each storage process transmits the current dataset to the interface at the same time.

Configuring the automatic storage function

- 1 Press the <STO__> key.
The menu for automatic storage appears.

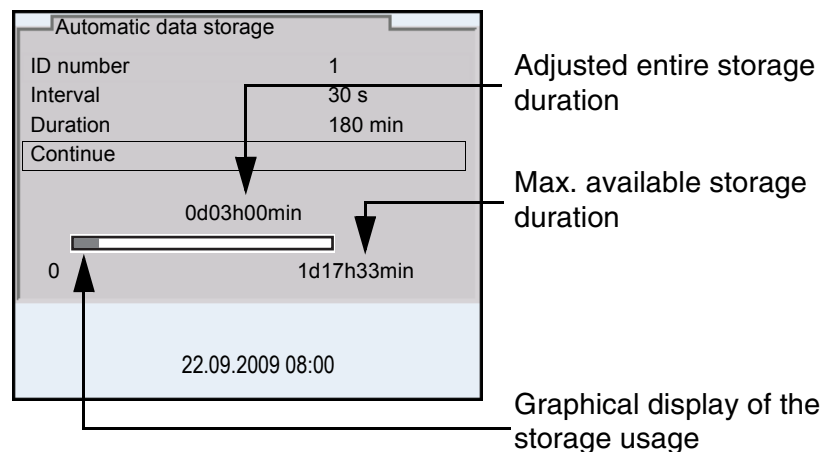

Settings

You can configure the automatic storage function with the following settings:

Menu item	Possible setting	Description
ID number	1 ... 10000	ID number for the dataset series.
<i>Interval</i>	1 s, 5 s, 10 s, 30 s, 1 min, 5 min, 10 min, 15 min, 30 min, 60 min	Storage interval. The lower limit of the storage interval can be restricted by the number of free storage locations. The upper limit is restricted by the storage duration.
<i>Duration</i>	1 min ... x min	Storage duration. Specifies after which time the automatic storage should be terminated. The lower limit of the storage duration is restricted by the storage interval. The upper limit is restricted by the number of free storage locations.

Starting the automatic storage function

To start the automatic storage function, select *Continue* with **<▲><▼>** and confirm with **<MENU/ENTER>**. The meter switches to the measured value display.

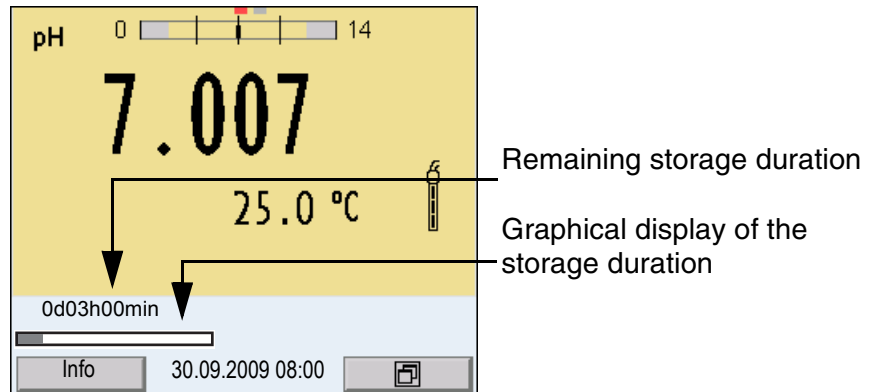

The active automatic storage function can be recognized by the progress bar in the status line. The progress bar indicates the remaining storage duration.



Note

If the automatic storage function is activated, only the following keys are active: Softkeys, **<M>**, **<STO__>** and **<On/Off>**. The other keys and the automatic switch-off function are deactivated.

Terminating the automatic storage function prematurely

Proceed as follows to switch off the automatic storage function before the adjusted storage duration has expired:

- 1 Press the **<STO__>** key.
The following window appears.

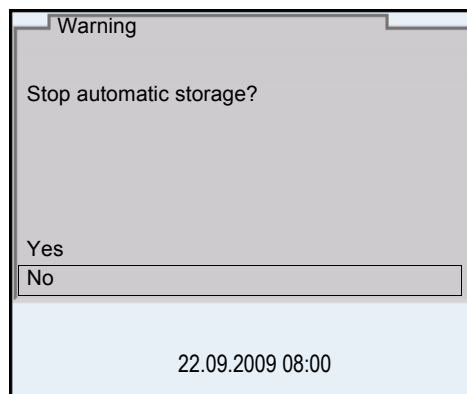

- 2 Using **<▲><▼>**, select **Yes** and confirm with **<MENU/ENTER>**.
The meter switches to the measured value display.
The automatic storage function is terminated.

4.9.3 Editing the measurement data storage

The contents of the manual or automatic measurement data storage can be shown on the display.

Each of the measurement data storages has a function to erase the entire contents.

Editing the data storage

The storage is edited in the menu, *Storage & config / Data storage*. To open the *Storage & config* menu, press the <MENU/ENTER__> key in the measured value display.

Open the manual or automatic storage directly with the <RCL> or <RCL__> key.



Note

The settings are explained here using the manual storage as an example. The same settings and functions are available for the automatic storage.

Settings

Menu item	Setting/function	Description
<i>Data storage / Manual data storage / Display</i>	-	Displays all measurement datasets page by page. <u>Further options:</u> <ul style="list-style-type: none"> ● Scroll through the datasets with <◀><▶>. ● Output the displayed dataset to the interface with <PRT>. ● Quit the display with <ESC>.
<i>Data storage / Manual data storage / Copy to USB flash drive</i>	-	Outputs all stored measurement data to a connected USB flash drive.
<i>Data storage / Manual data storage / Output to RS232/USB</i>	-	Outputs all stored measurement data to the interface.

Menu item	Setting/function	Description
<i>Data storage / Manual data storage / Erase</i>	-	Erases the entire manual measurement data storage. <u>Note:</u> All calibration data remains stored when this action is performed.

Display presentation of a dataset

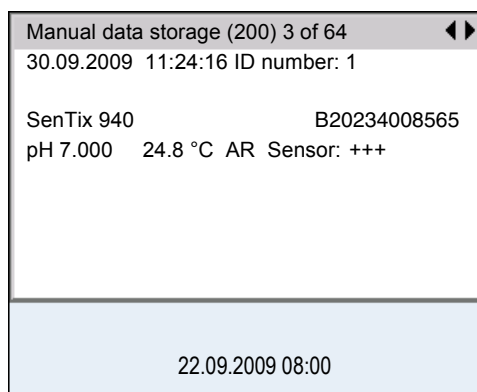

Sample printout

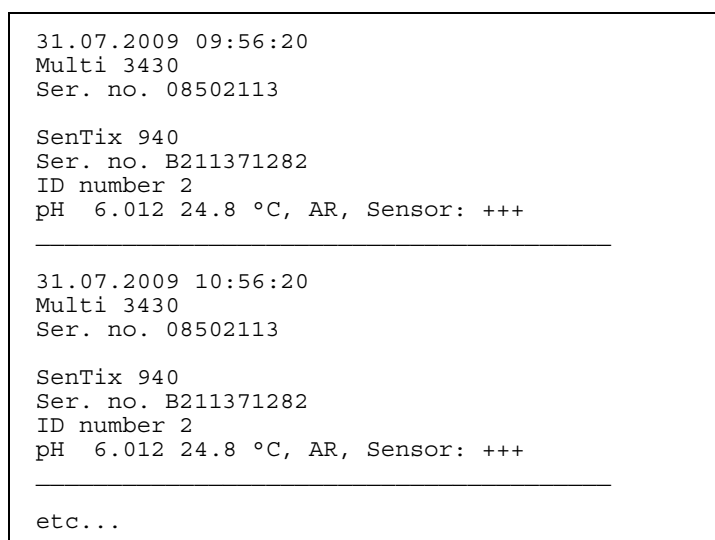

Quitting the display

To quit the display of stored measurement datasets, you have the following options:

- Switch directly to the measured value display with **<M>**.
- Quit the display and move to the next higher menu level with

<ESC>.

4.9.4 Erasing the measurement data storage

How to erase the measurement data memory is described in section 4.9.3 EDITING THE MEASUREMENT DATA STORAGE.

4.10 Transmitting data (USB interfaces)

4.10.1 Outputting current measurement data

- | | |
|---|--|
| 1 | Output the current measurement data to the USB-B interface with <PRT> . |
|---|--|

4.10.2 Transmitting data (to a PC)

The meter has the following interfaces:

- USB-B interface (*USB Device*)
e.g. to connect a PC
- USB-A interface (*USB Host*),
e.g. to connect a USB flash drive

Via the USB-B interface (*USB Device*) you can transmit data to a PC or printer and update the meter software.

Via the USB-A interface (*USB Host*) it is possible to transfer data to an external USB memory device.

4.10.3 Connecting the PC / USB-B interface (*USB Device*)

Connect the Multi 3430 to the PC via the USB-B interface.

System requirements of the PC for installation of the USB driver:

- PC with at least one free USB connection and CD-ROM drive
- Windows 2000, XP, Vista.

- | | |
|---|--|
| 1 | Insert the supplied installation CD in the CD drive of your PC. |
| 2 | Install the driver from the CD.
Follow the Windows installation instructions as necessary. |
| 3 | Connect the Multi 3430 to the PC via the USB-B interface.
The meter is listed as a virtual COM interface among the connections in the Windows instrument manager. |

Installation of the USB driver on the PC

- 4 | Set the same transmission data at the connected instrument (PC):
 - Baud rate: to be selected in the range 1200 ... 19200
 - Handshake: RTS/CTS
 - Set at the PC only:
 - Parity: none
 - Data bits: 8
 - Stop bits: 1

4.10.4 Connecting the USB memory device / USB-A interface (*USB Host*)

Connect the USB-A interface (*USB Host*) of the Multi 3430 to a USB flash drive.

- 1 | Connect the USB printer or a USB memory device to the *USB Host* interface.

4.10.5 Options for data transmission

Via the USB-B interface you can transmit data to a PC. Via the USB-A interface you can transmit data to a USB memory device. The following table shows which data are transmitted to the interface in which way:

Data	Control	Operation / description
Current measured values of all connected sensors	Manual	<ul style="list-style-type: none"> ● With <PRT>. ● Simultaneously with every manual storage process (see section 4.9.1).
	Automatic, at intervals	<ul style="list-style-type: none"> ● With <PRT__>. Then you can set the transmission interval. ● Simultaneously with every automatic storage process (see section 4.9.2).
Stored measured values	Manual	<ul style="list-style-type: none"> ● Displayed dataset with <PRT> after calling up from the storage. ● All datasets with the <i>Output to RS232/USB</i> function. <p>For details, see section 4.9.3.</p>
Calibration records	Manual	<ul style="list-style-type: none"> ● Displayed calibration record with <PRT>. ● All calibration records with <PRT__>. <p>For details, see section 4.10.</p>
	Automatic	<ul style="list-style-type: none"> ● At the end of a calibration procedure.



Note

The following rule applies: With the exception of the menus, shortly pressing the **<PRT>** key generally outputs the display contents to the interface (displayed measured values, measuring datasets, calibration records).

4.11 Reset

You can reset (initialize) all sensor settings and sensor-independent settings separately from each other.

4.11.1 Resetting the measurement settings



Note

The calibration data are reset to the default settings together with the measuring parameters. Recalibrate after performing a reset.

pH

The following settings for pH measurements are reset to the default settings with the *Reset* function:

Setting	Default settings
<i>Buffer</i>	AutoCalTEC
<i>Cal. interval</i>	7 d
<i>Unit for slope</i>	mV/pH
Measured parameter	pH
Resolution pH	0.001
Resolution mV	0.1
Asymmetry	0 mV
Slope	-59.2 mV
<i>Man. temperature</i>	25 °C
<i>Single-point calibration</i>	Off
Stability control	On

The sensor settings are reset under the *Reset* menu item in the menu for calibration and measurement settings. To open the settings, display the required measured parameter in the measured value display and press the <MENU/ENTER> key.

ORP The following settings for ORP measurements are reset to the default settings with the *Reset* function:

Setting	Default settings
Resolution mV	0.1
<i>Man. temperature</i>	25 °C
Stability control	<i>On</i>

The sensor settings are reset under the *Reset* menu item in the menu for calibration and measurement settings. To open the settings, display the required measured parameter in the measured value display and press the <MENU/ENTER> key.

Conductivity The following settings for conductivity measurements are reset to the default settings with the *Reset* function:

Setting	Default settings
Cal. interval	150 d
Measured parameter	æ
Cell constant (c)	Depending on the connected measuring cell: 0.475 cm ⁻¹ (calibrated) 0.475 cm ⁻¹ (set up) 0.100 cm ⁻¹
Temperature compensation	nLF
Reference temperature	25 °C
Temperature coefficient (TC) of the linear temperature compensation	2.000 %/K
TDS factor	1.00
Stability control	On

The sensor settings are reset under the *Reset* menu item in the menu for calibration and measurement settings. To open the settings, display the required measured parameter in the measured value display and press the <MENU/ENTER> key.

4.11.2 Resetting the system settings

The following system settings can be reset to the default condition:

Setting	Default settings
<i>Language</i>	English
<i>Acoustic signal</i>	On
<i>Volume</i>	5
<i>Baud rate</i>	4800 Baud
<i>Output format</i>	ASCII
<i>Decimal separator</i>	.
<i>Brightness</i>	10
<i>Illumination</i>	Auto
<i>Switchoff time</i>	1 h
Temperature unit	°C
<i>USB Host</i>	On

The system settings are reset in the menu, *Storage & config / System / Reset*. To open the *Storage & config* menu, press the **<MENU/ENTER__>** key in the measured value display.

5 Maintenance, cleaning, disposal

5.1 Maintenance

The only maintenance activity required is replacing the batteries.



Note

See the relevant operating manuals of the IDS sensors for instructions on maintenance.

5.1.1 Replacing the rechargeable batteries

1	Unscrew the two screws (1) on the underside of the meter.
2	Open the battery compartment (2) on the underside of the meter.

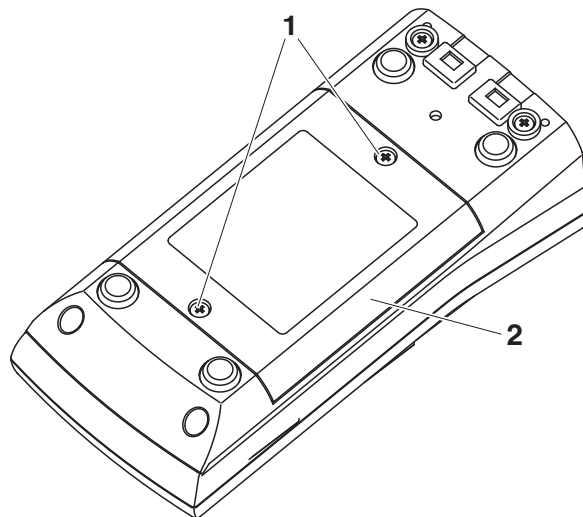

3	Remove the four rechargeable batteries from the battery compartment.
4	Place four new rechargeable batteries (type Mignon AA) in the battery compartment.



CAUTION

Make sure that the poles of the rechargeable batteries are positioned correctly.

The \pm signs on the batteries must correspond to the \pm signs in the battery compartment.

- 5 Close the battery compartment (2) and tighten the screws (1).

5.2 Cleaning

Occasionally wipe the outside of the measuring instrument with a damp, lint-free cloth. Disinfect the housing with isopropanol as required.



CAUTION

The housing is made of synthetic material (ABS). Thus, avoid contact with acetone or similar detergents that contain solvents. Remove any splashes immediately.

5.3 Packing

This meter is sent out in a protective transport packing. We recommend: Keep the packing material. The original packing protects the meter against damage during transport.

5.4 Disposal



Note

This meter contains rechargeable batteries. Batteries that have been removed must only be disposed of at a recycling facility set up for this purpose or via the retail outlet.

It is illegal to dispose of the batteries in household refuse.

6 What to do if...

6.1 General information

Sensor symbol flashes	Cause – Calibration interval expired	Remedy – Recalibrate the measuring system
 Display	Cause – Batteries almost empty	Remedy – Charge the batteries (see section 3.3.2 CONNECTING THE POWER PACK / CHARGING THE BATTERIES) – Replace the batteries (see section 5.1 MAINTENANCE)
Meter does not react to keystroke	Cause – Operating condition undefined or EMC load unallowed	Remedy – Processor reset: Press the <MENU/ENTER> and <On/Off> key simultaneously
You want to know which software version is in the meter	Cause – E. g., a question by the service department	Remedy – Switch on the meter. Open the menu, <MENU/ENTER__> / <i>Storage & config / System / Service information</i> . The instrument data is displayed.

6.2 pH

Error message *OFL, UFL*

Cause	Remedy
IDS pH sensor:	
– Measured value outside the measuring range	– Use suitable IDS pH sensor
– Air bubble in front of the diaphragm	– Remove air bubble
– Air in the diaphragm	– Extract air or moisten diaphragm
– Cable broken	– Exchange IDS pH sensor
– Gel electrolyte dried out	– Exchange IDS pH sensor

Error message, *Error*

Cause	Remedy
IDS pH sensor:	
– The values determined for zero point and slope of the IDS pH sensor are outside the allowed limits.	– Recalibrate
– Junction contaminated	– Clean the junction
– IDS pH sensor broken	– Exchange IDS pH sensor
– Buffer solutions:	
– Wrong buffer solutions	– Change calibration procedure
– Buffer solutions too old	– Use only once. Note the shelf life
– Buffer solutions depleted	– Change solutions

No stable measured value

Cause	Remedy
IDS pH sensor:	
– Junction contaminated	– Clean the junction
– Membrane contaminated	– Clean membrane
Test sample:	
– pH value not stable	– Measure with air excluded if necessary
– Temperature not stable	– Adjust temperature if necessary
IDS pH sensor + test sample:	
– Conductivity too low	– Use suitable IDS pH sensor
– Temperature too high	– Use suitable IDS pH sensor
– Organic liquids	– Use suitable IDS pH sensor

Obviously incorrect measured values

Cause	Remedy
IDS pH sensor:	
– IDS pH sensor unsuitable	– Use suitable IDS sensor
– Temperature difference between buffer and test sample too great	– Adjust temperature of buffer or sample solutions
– Measurement procedure not suitable	– Follow special procedure

6.3 Conductivity

**Error message,
*OFL*****Cause**

- Measured value outside the measuring range

Remedy

- Use suitable IDS conductivity sensor

**Error message,
*Error*****Cause**

- IDS conductivity sensor contaminated

Remedy

- Clean and if necessary, exchange IDS conductivity sensor

- Calibration solution not suitable

- Check calibration solutions

7 Technical data

7.1 General data

Dimensions	Approx. 180 x 80 x 55 mm	
Weight	Approx. 0.4 kg	
Mechanical structure	Type of protection	IP 67
Electrical safety	Protective class	III
Test certificates	CE	
Ambient conditions	Storage	- 25 °C ... + 65 °C
	Operation	-10 °C ... + 55 °C
	Climatic class	2
Power supply	Rechargeable batteries	4 x 1.2 V NiMH rechargeable batteries, type AA
	Operational life	Approx. 150 h [#]
USB interface (device)	Type	USB 1.1 USB-B (Device), PC
	Baud rate	adjustable: 1200, 2400, 4800, 9600, 19200 Baud
	Data bits	8
	Stop bits	2
	Parity	None
	Handshake	RTS/CTS
	Cable length	max. 3 m
USB interface (host)	Type	USB 2.0 USB-A (host), USB device

[#] The operational life is shorter if, e.g.

- several sensors are operated
- the maximum display illumination is set

Applicable directives and standards

EMC	EC directive 2004/108/EC EN 61326-1 EN 61000-3-2 EN 61000-3-3 FCC Class A
Meter safety	EC directive 2006/95/EC EN 61010-1
Climatic class	VDI/VDE 3540
IP protection class	EN 60529

FCC Class A Equipment Statement

Note: This equipment has been tested and found to comply with the limits for a Class A digital device, pursuant to Part 15 of the FCC Rules. These limits are designed to provide reasonable protection against harmful interference when the equipment is operated in a commercial environment. This equipment generates, uses, and can radiate radio frequency energy and, if not installed and used in accordance with the instruction manual, may cause harmful interference to radio communications. Operation of this equipment in a residential area is likely to cause harmful interference in which case the user will be required to correct the interference at his own expense. Changes or modifications not expressly approved by the manufacturer could void the user's authority to operate the equipment.

7.2 Measuring ranges, resolution, accuracy

Note

These data are given in the documentation of your sensor.

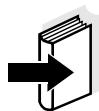

8 Lists

This chapter provides additional information and orientation aids.

Specialist terms The glossary briefly explains the meaning of the specialist terms. However, terms that should already be familiar to the target group are not described here.

Index The index will help you to find the topics that you are looking for.

Glossary

Adjusting To manipulate a measuring system so that the relevant value (e. g. the displayed value) differs as little as possible from the correct value or a value that is regarded as correct, or that the difference remains within the tolerance.

Asymmetry see zero point

AutoRange Name of the automatic selection of the measuring range.

Calibration Comparing the value from a measuring system (e. g. the displayed value) to the correct value or a value that is regarded as correct. Often, this expression is also used when the measuring system is adjusted at the same time (see adjusting).

Electromotive force of an electrode The electromotive force U of the combination electrode is the measurable electromotive force of an electrode in a solution. It equals the sum of all the galvanic voltages of the combination electrode. Its dependency on the pH results in the electrode function, which is characterized by the parameters, slope and zero point.

Junction The junction is a porous body in the housing wall of reference electrodes or electrolyte bridges. It arranges the electrical contact between two solutions and makes the electrolyte exchange more difficult. The expression, junction, is also used for ground or junctionless transitions.

Measured parameter The measured parameter is the physical dimension determined by measuring, e. g. pH, conductivity or D.O. concentration.

Measured value The measured value is the special value of a measured parameter to be determined. It is given as a combination of the numerical value and unit (e. g. 3 m; 0.5 s; 5.2 A; 373.15 K).

ORP voltage	The ORP is caused by oxidizing or reducing substances dissolved in water if these substances become effective on an electrode surface (e. g. a gold or platinum surface).
pH value	The pH value is a measure of the acidic or basic effect of an aqueous solution. It corresponds to the negative decadic logarithm of the molal hydrogen ions activity divided by the unit of the molality. The practical pH value is the value of a pH measurement.
Potentiometry	Name of a measuring technique. The signal (depending on the measured parameter) of the electrode is the electrical potential. The electrical current remains constant.
Reset	Restoring the original condition of all settings of a measuring system.
Resolution	Smallest difference between two measured values that can be displayed by a meter.
Slope	The slope of a linear calibration function.
Stability control (AutoRead)	Function to control the measured value stability.
Standard solution	The standard solution is a solution where the measured value is known by definition. It is used to calibrate a measuring system.
Test sample	Designation of the test sample ready to be measured. Normally, a test sample is made by processing the original sample. The test sample and original sample are identical if the test sample was not processed.
Zero point	The zero point of a pH combination electrode is the pH value at which the electromotive force of the pH combination electrode at a specified temperature is zero. Normally, this is at 25 °C.

A

Authorized use	16
Automatic switch-off	23
AutoRead	64
ORP	61
pH	37

B

Battery compartment	19, 87
---------------------------	--------

C

Calibration	70
pH	41
Calibration evaluation	70
pH	46
Calibration interval	47
Calibration points	
pH	45
calibration records	54, 72
Cell constant	70
Connect the power pack	20
Connecting a PC	80, 81

D

Dataset	73
Date and time	30
Default settings	
Measured parameter	83
System settings	85
Display	9

E

Energy saving feature	21
-----------------------------	----

F

Firmware update	99
-----------------------	----

I

Initial commissioning	19, 21
Initialize	83
Interval for calibration	47

K

Keys	8
------------	---

M

Measured value display	26
Measurement accuracy	47
Measurement data storage	
Edit	77
Erase	77
Storage locations	73
Measurement dataset	73
Measuring	63
ORP voltage	60
pH	37
Menu for calibration and measurement settings	
.....	67
pH/ORP	39, 62
Menus (navigation)	26
Messages	27

O

Operational safety	16
--------------------------	----

P

pH buffer sets	41
Precautions	15
Print	82

R

Reset	83
RS232 interface	81

S

Safety	15
Scope of delivery	19
Setting the date	21
Setting the time	21
Single-point calibration	
pH	49, 52, 53
Slope	
pH	41
Socket field	11
Stability control	
automatic	34
Storage interval	75
Storing in memory	73
Automatic	75
Manual	74

T

Temperature compensation	66
Temperature measurement	63
pH	36
Three-point calibration	
pH	50
Transmitting data	80
Transmitting measured values	80
Two-point calibration	
pH	49, 52, 54

Z

Zero point of pH combination electrode ..	41
---	----

9 Appendix: Firmware update

General information

Available firmware updates are provided on the Internet. With the "Firmware Update " program and a PC you can update the firmware of the Multi 3430 to the newest version.

For the update you have to connect the meter to a PC.

For the update via the USB-B interface, the following is required:

- a free USB interface (virtual COM port) on the PC
- the driver for the USB interface (on the enclosed CD-ROM)
- the USB cable (included in the scope of delivery of the Multi 3430).

Program installation

- | | |
|---|--|
| 1 | Install the downloaded firmware update on a PC.

An update folder is created in the Windows start menu. If an update folder already exists for the meter (or meter type), the new data is displayed there. |
|---|--|

Program start

- | | |
|---|--|
| 2 | In the windows start menu, open the update folder and start the firmware update program. |
|---|--|

Firmware update

- | | |
|---|---|
| 3 | Using the USB interface cable, connect the Multi 3430 to a USB interface (virtual COM port) of the PC. |
| 4 | Switch on the Multi 3430. |
| 5 | In the firmware update program, start the update process with OK. |
| 6 | Follow the instructions of the firmware update program. During the programming process, a corresponding message and a progress bar (in %) are displayed. The programming process takes up to 30 minutes. A terminatory message is displayed after a successful programming process. The firmware update is completed. |
| 7 | Disconnect the Multi 3430 from the PC. The Multi 3430 is ready for operation again. |

After switching the meter off and on you can check whether the meter has taken over the new software version (see page 89).

Distributed By

Lab Unlimited
CARL STUART GROUP

Web: www.labunlimited.com Email: info@labunlimited.com



Wissenschaftlich-Technische Werkstätten GmbH

Dr.-Karl-Slevogt-Straße 1
D-82362 Weilheim

Germany

Tel: +49 (0) 881 183-0
+49 (0) 881 183-100
Fax: +49 (0) 881 183-420
E-Mail: Info@WTW.com
Internet: <http://www.WTW.com>