

ba52308e **Handheld meter
pH 315i**

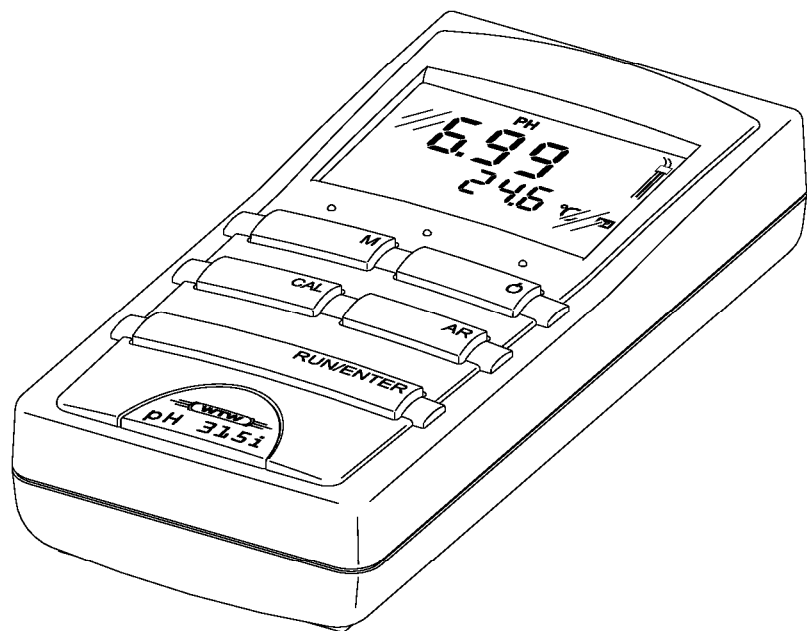

Distributed by:



ADVANCED APPLIED TECHNOLOGIES

Contact Us:

Irl Ph: 01 4523432

UK Ph: 08452 30 40 30

Web: www.carlstuart.com

Email: info@carlstuart.com

pH measuring instrument

**Accuracy when
going to press**

The use of advanced technology and the high quality standard of our instruments are the result of continuous development. This may result in differences between this operating manual and your instrument. Also, we cannot guarantee that there are absolutely no errors in this manual. Therefore, we are sure you will understand that we cannot accept any legal claims resulting from the data, figures or descriptions.

Warranty

We guarantee the instrument described for 3 years from the date of purchase.

The instrument warranty covers manufacturing faults that are discovered within the warranty period. The warranty does not cover components that are replaced during maintenance work, e.g. batteries.

The warranty claim extends to restoring the instrument to readiness for use but not, however, to any further claim for damages. Improper handling or unauthorized opening of the instrument invalidates any warranty claim.

To ascertain the warranty liability, return the instrument and proof of purchase together with the date of purchase freight paid or prepaid.

Copyright

© Weilheim 2004, WTW GmbH

Reproduction in whole - or even in part - is prohibited without the express written permission of WTW GmbH, Weilheim.

Printed in Germany.

Contents

1	Overview	5
1.1	SETs of equipment	6
1.2	Keypad	7
1.3	Display	8
1.4	Jack field	8
2	Safety	9
2.1	Authorized use	9
2.2	General safety instructions	10
3	Commissioning	11
4	Operation	13
4.1	Switching on the measuring instrument	13
4.2	Measuring	14
4.2.1	Measuring the pH value	15
4.2.2	Measuring the ORP voltage	16
4.3	Calibrating	17
4.3.1	AutoCal TEC	19
4.3.2	AutoCal DIN	24
4.4	Configuration	29
4.5	Reset	30
5	Maintenance, cleaning, disposal	31
5.1	Maintenance	31
5.2	Cleaning	32
5.3	Disposal	32
6	What to do if...	33
7	Technical data	37
8	Lists	39

1 Overview

The compact precision pH 315i handheld meter enables you to carry out pH measurements rapidly and reliably.

The pH 315i handheld meter provides the maximum degree of operating comfort, reliability and measuring certainty for all applications.

The proven MultiCal[®] calibration procedure and the special AutoRead function support you in your work with the pH handheld meter.

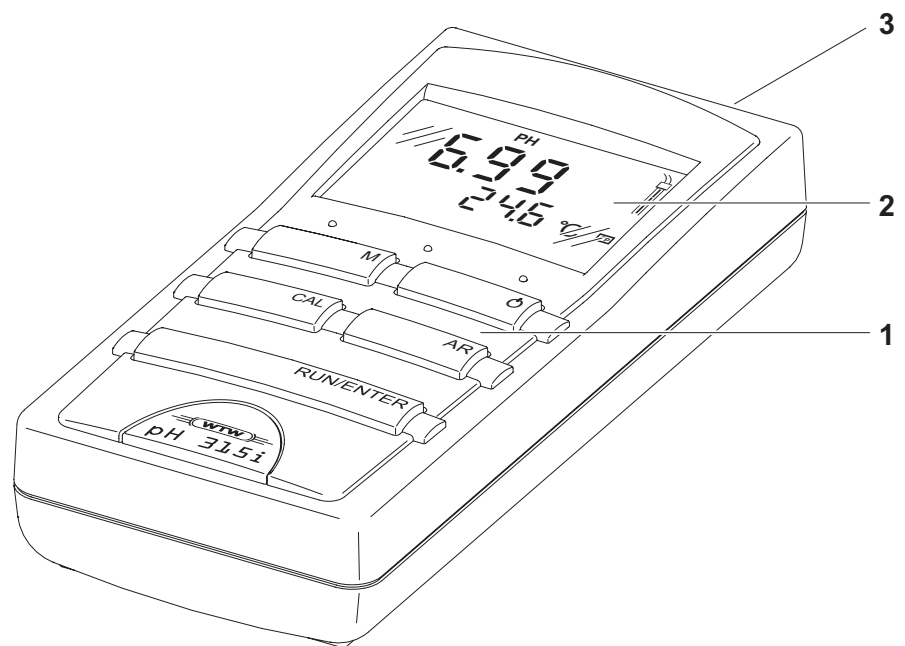

1	Keypad
2	Display
3	Jack field



Note

If you need further information or application notes, you can obtain the following material from WTW:

- Application reports
- Primers
- Safety datasheets.

You will find information on available literature in the WTW catalog or via the Internet.

1.1 SETs of equipment

The measuring instrument is also available as part of individual SETs of equipment.

You will find additional information on this and other accessories in the WTW catalog or via the Internet.

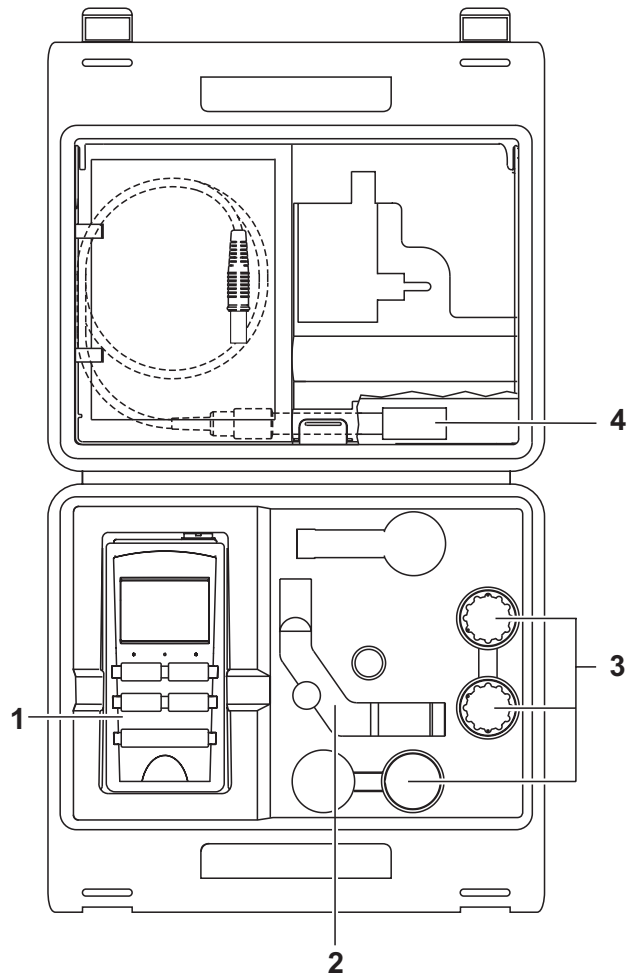

Set (sample configuration):

1	Measuring instrument, pH 315i
2	Stand
3	<ul style="list-style-type: none"> – KCl solution for electrodes – 50 ml pH buffer solution, STP 4 – 50 ml pH buffer solution, STP 7 – Beaker, 50 ml
4	pH electrode

1.2 Keypad

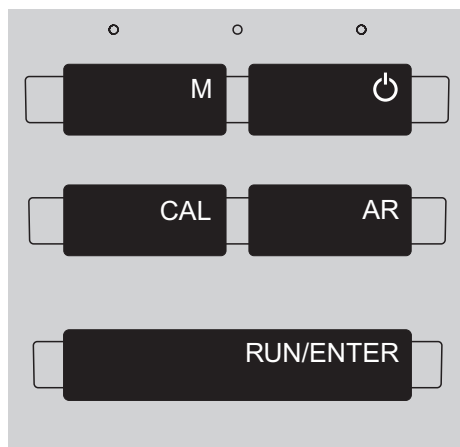

Key functions

M	Select the measuring mode <M> : – pH value – ORP voltage
⏻	Switch measuring instrument on/off <ON/OFF>
CAL	Calibrate, select the calibration procedure <CAL>
AR	Activate/deactivate the AutoRead function <AR>
RUN/ENTER	Confirm entries, start AutoRead <RUN/ENTER>

1.3 Display

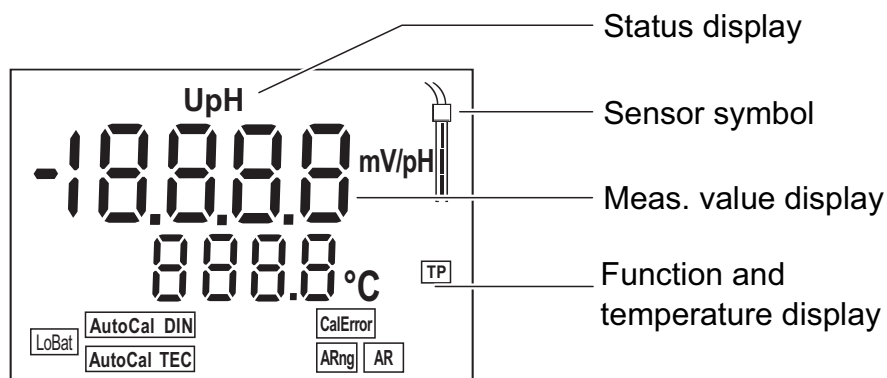

1.4 Jack field

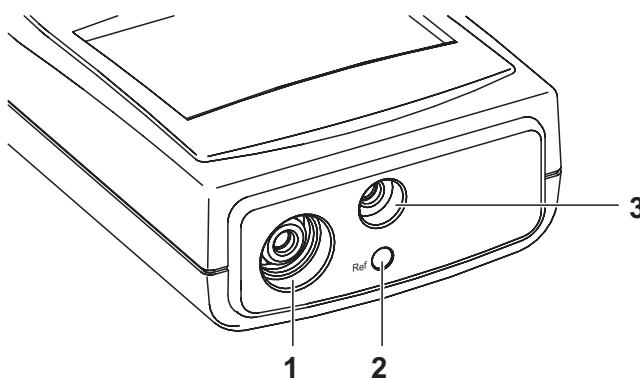

1	pH electrode
2	Reference electrode
3	Temperature probe



Warning

Only connect electrodes to the measuring instrument that do not return any unallowed voltages or currents (> SELV and > current circuit with current limiting).

Almost all electrodes - in particular WTW electrodes - fulfill these conditions.

2 Safety

This operating manual contains basic instructions that you must follow during the commissioning, operation and maintenance of the measuring instrument. Consequently, all responsible personnel must read this operating manual carefully before working with the measuring system. The operating manual must always be available within the vicinity of the measuring system.

Target group

The measuring instrument was developed for work in the field and in the laboratory. We assume that, as a result of their professional training and experience, the operators will know the necessary safety precautions to take when handling chemicals.

Symbols used



Warning

indicates instructions that must be followed to prevent damage to your instrument.



Note

indicates notes that draw your attention to special features.



Note

indicates cross-references to other documents, e.g. application reports, operating manuals of probes, etc.

2.1 Authorized use

The authorized use of the measuring instrument consists exclusively of the pH and ORP measurement in the field and laboratory.

The technical specifications as given in chapter 7 TECHNICAL DATA must be observed. Only the operation and running of the measuring instrument according to the instructions given in this operating manual is authorized.

Any other use is considered to be **unauthorized**.

2.2 General safety instructions

This instrument is built and inspected according to the relevant guidelines and norms for electronic measuring instruments (see chapter 7 TECHNICAL DATA).

It left the factory in a safe and secure technical condition.

Function and operating safety

The smooth functioning and operational safety of the measuring instrument can only be guaranteed if the generally applicable safety measures and the specific safety instructions in this operating manual are followed during operation.

The smooth functioning and operational safety of the measuring instrument can only be guaranteed under the environmental conditions that are in specified in chapter 7 TECHNICAL DATA.

If the instrument was transported from a cold environment to a warm environment, the formation of condensate can lead to the faulty functioning of the instrument. In this event, wait until the temperature of the instrument reaches room temperature before putting the instrument back into operation.

Safe operation

If safe operation is no longer possible, the instrument must be taken out of service and secured against inadvertent operation!

Safe operation is no longer possible if the measuring instrument:

- has been damaged in transport
- has been stored under adverse conditions for a lengthy period of time
- is visibly damaged
- no longer operates as described in this manual.

If you are in any doubt, please contact the supplier of the instrument.

Obligations of the purchaser

The purchaser of the measuring instrument must ensure that the following laws and guidelines are observed when using dangerous substances:

- EEC directives for protective labor legislation
- National protective labor legislation
- Safety regulations
- Safety datasheets of the chemical manufacturers.

3 Commissioning

Scope of delivery

- Handheld meter, pH 315i
- Operating manual and short operating manual
- 4 batteries, 1.5 V Mignon type AA (in the instrument)

For details of scope of delivery of SETs, see chapter 1.1 SETs OF EQUIPMENT and WTW catalog.

4 Operation

4.1 Switching on the measuring instrument

- | | |
|---|---|
| 1 | <p>Press the <ON/OFF> key.</p> <p>The display test appears briefly on the display. Subsequently, the slope and asymmetry that are used appear for approx. one second one after the other. In addition, the calibration procedure of the last calibration is shown (<i>AutoCal TEC</i> or <i>AutoCal DIN</i>, or no display in the delivery state or after a reset). The measuring instrument then switches to the measuring mode that was last selected.</p> |
| 2 | <p>Connect the pH electrode to the measuring instrument. The instrument is ready for operation.</p> |

4.2 Measuring

Preparatory activities

Perform the following preparatory activities when you want to measure:

1	Connect the electrode to the measuring instrument.
2	Calibrate or check the measuring instrument with the electrode.
3	Select the measuring mode with <M> .



Note

Incorrect calibration of pH electrodes leads to incorrect measured values. Calibrate regularly before measuring.

Temperature sensor

Basically, pH measurements should only be performed using a temperature probe. The temperature probe is shown on the display by *TP*.

If you nevertheless use an electrode without a temperature probe, the instrument operates with a reference temperature of 25 °C. Thus, the sample and calibration solution must have their temperatures adjusted to 25 °C in order to avoid larger measurement errors.



Note

The pH meter automatically recognizes the type of temperature probe used. This enables electrodes to be connected with the NTC30 or Pt1000.

4.2.1 Measuring the pH value

1	Perform the preparatory activities according to section 4.2.
2	Immerse the pH electrode into the test sample.
3	Press the <M> key until <i>pH</i> appears on the status display. The pH value appears on the display.

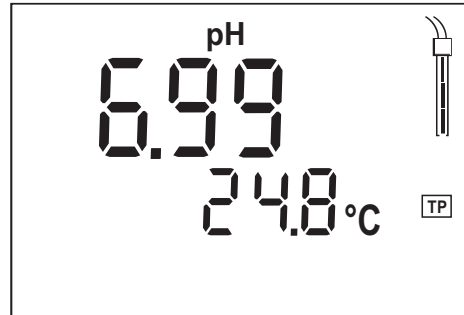

Changing the pH resolution

The measuring instrument shows the pH measured value with a resolution of 0.01 or 0.001 (default setting is 0.01). To change over the resolution, press the **<M>** key while pressing the **<RUN/ENTER>** key.

AutoRead AR (drift control)

The AutoRead function (drift control) checks the stability of the measurement signal. The stability has a considerable impact on the reproducibility of the measured values.

For identical measurement conditions, the following criteria apply:

Reproducibility	Response time
Better than 0.02	> 30 seconds

1	Call up the pH measuring mode with <M> .
2	Activate the AutoRead function with <AR> . The current measured value is frozen (hold function).
3	Start AutoRead with <RUN/ENTER> . The AR display indicator flashes until a stable signal is reached.
4	If necessary, start the next AutoRead measurement with <RUN/ENTER> .
5	To terminate AutoRead: Press the <AR> key.



Note

The current AutoRead measurement can be terminated at any time (accepting the current value) by pressing **<RUN/ENTER>**.

4.2.2 Measuring the ORP voltage

In conjunction with an ORP electrode, e.g. SenTix ORP, the measuring instrument can measure the ORP voltage (U) of a solution.

1	Perform the preparatory activities according to section 4.2.
2	Immerse the ORP electrode in the test sample.
3	Press the <M> key until U appears on the status display. The ORP voltage (mV) of the sample appears on the display.
4	Wait for a stable measured value.

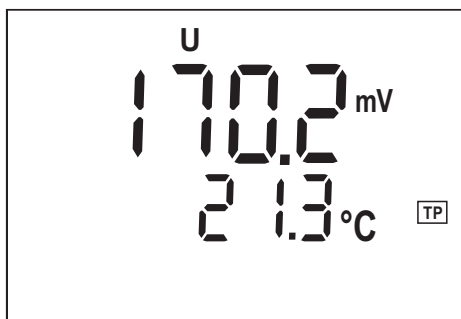

Note

ORP electrodes are not calibrated. However, you can check ORP electrodes using a test solution.

4.3 Calibrating

Why calibrate?

pH electrodes age. This changes the asymmetry (zero point) and slope of the pH electrode. As a result, an inexact measured value is displayed. Calibration determines the current values of the asymmetry and slope of the electrode and stores them in the measuring instrument.

Thus, you should calibrate at regular intervals.



Note

Always calibrate after replacing the pH electrode.

You can select between two calibration procedures:

AutoCal TEC

is specially adapted to the WTW technical buffer solutions as a fully automatic **two-point** or **three-point calibration**. The buffer solutions are automatically recognized by the measuring instrument. Depending on the instrument setting (see section 4.4 CONFIGURATION), the instrument displays the relevant buffer nominal value or the current electrode voltage in mV. The calibration can be terminated after the first buffer solution. This corresponds to a **single-point calibration**. To do this, the instrument uses the standard slope (-59.2 mV/pH at 25 °C) and determines the asymmetry of the electrode.

AutoCal DIN

is specially adapted to the permanently programmed buffer solutions in accordance with DIN 19266 as a fully automatic **two-point** or **three-point calibration**. The operating sequence of the AutoCal DIN calibration corresponds to that of the AutoCal TEC calibration. The calibration can only be terminated after the first buffer solution (**single point calibration**).

AutoRead

When calibrating with AutoCal TEC and AutoCal DIN, the AutoRead function is automatically activated.





The current AutoRead measurement can be terminated at any time (accepting the current value) by pressing **<RUN/ENTER>**.

Displaying calibration data

Each time the instrument is switched on, the calibration data are shown on the display for a short time (see section 4.1 SWITCHING ON THE MEASURING INSTRUMENT). In order to view the calibration data, switch the measuring instrument off and switch it on again.

Calibration evaluation

After the calibration, the measuring instrument automatically evaluates the current status of the electrode. The asymmetry and slope are evaluated separately. The worst evaluation appears on the display.

Display	Asymmetry [mV]	Slope [mV/pH]
	-15 ... +15	-60.5 ... -58
	-20 ... +20	-58 ... -57
	-25 ... +25	-61 ... -60.5 or -57 ... -56
 Clean the electrode according to the electrode operating manual	-30 ... +30	-62 ... -61 or -56 ... -50
E3 Eliminate the error according to chapter 6 WHAT TO DO IF...	< -30 or > 30	... -62 or ... -50

- | | |
|---|--|
| 1 | Connect the pH electrode to the measuring instrument. |
| 2 | Keep the buffer solutions ready. |
| 3 | Adjust the temperature of the solution and measure the current temperature if the measurement is made without the use of a temperature sensor (the <i>TP</i> display indicator is missing from the display). |

4.3.1 AutoCal TEC

For this procedure, use any two or three WTW technical buffer solutions in ascending or descending order (pH values at 25 °C: 2.00 / 4.01 / 7.00 / 10.01).



Note

The calibration for pH 10.01 is optimized for the WTW technical buffer solution TEP 10 Trace or TPL 10 Trace. Other buffer solutions can lead to an erroneous calibration. The correct buffer solutions are given in the WTW catalog or in the Internet.



Note

The buffer solutions are automatically recognized by the measuring instrument. Depending on the instrument setting (see section 4.4 CONFIGURATION), the instrument displays the relevant buffer nominal value or the current electrode voltage in mV.

- 1 Press the **<CAL>** key repeatedly until the *Ct1* display indicator and the function display *AutoCal TEC* appears. The sensor symbol displays the evaluation of the last calibration (or no sensor symbol in the delivery state or after the measurement parameter has been reset).

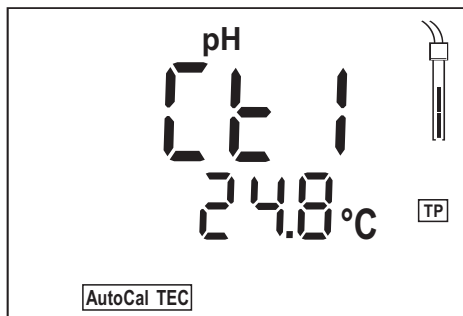

- 2 Immerse the pH electrode in the first buffer solution.
- 3 Press the **<RUN/ENTER>** key. The *AR* display indicator flashes.
The electrode voltage (mV) or the buffer nominal value appears on the display. Example:

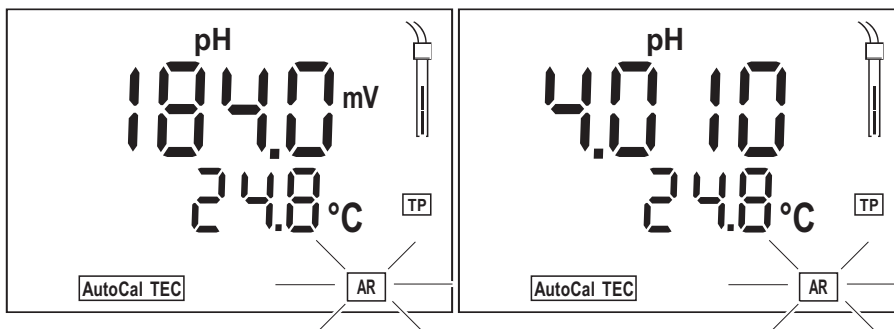

4 | When the measured value is stable, Ct2 appears.

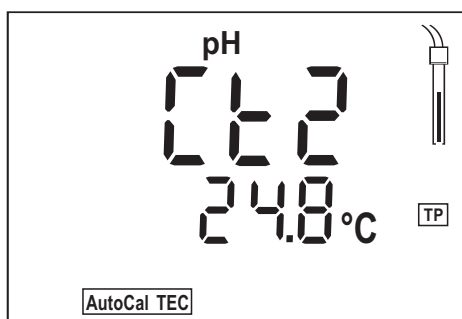

Note

At this point, the AutoCal TEC calibration can be terminated with **<M>**. This corresponds to a **single-point calibration**. To do this, the instrument uses the standard slope (-59.2 mV/pH at 25 °C) and determines the asymmetry of the electrode.

- 5 | Thoroughly rinse the electrode with deionized water.
- 6 | Immerse the pH electrode in the second buffer solution.
- 7 | Press the **<RUN/ENTER>** key.
The AR display indicator flashes.
The electrode voltage (mV) or the buffer nominal value appears on the display. Example:

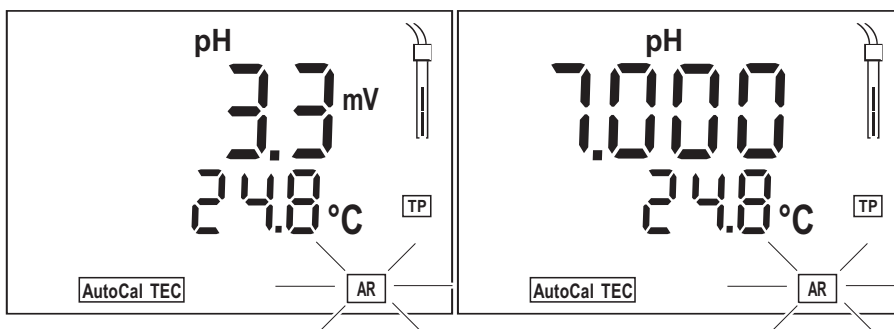

- 8 When the measured value is stable, *AR* disappears. The value of the slope (mV/pH) appears on the display. The probe symbol shows the evaluation of the current calibration (two-point calibration).

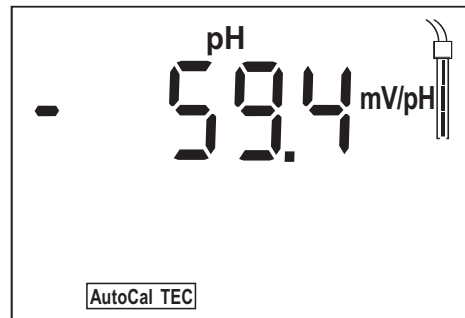

- 9 Press the **<RUN/ENTER>** key. The value of the asymmetry (mV) appears on the display.

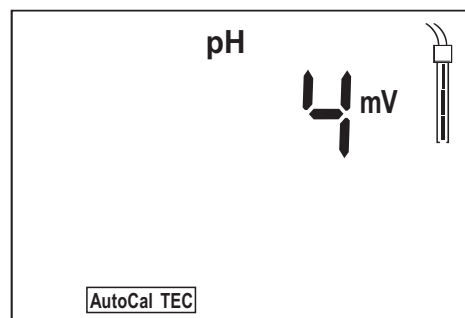

- 10 Change to the measuring mode with **<M>**, or proceed to the three-point calibration with **<RUN/ENTER>**.

Three-point calibration

11 | Press the <RUN/ENTER> key. Ct3 appears on the display.

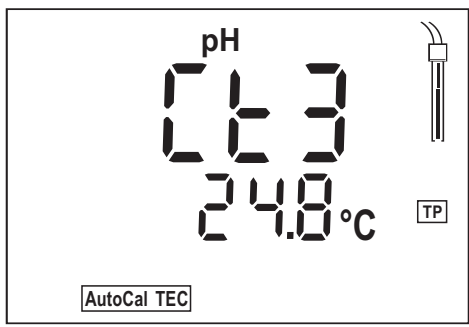

12 | Thoroughly rinse the electrode with distilled water.

13 | Immerse the pH electrode in the third buffer solution.

14 | Press the <RUN/ENTER> key.
The AR display indicator flashes.
The electrode voltage (mV) or the buffer nominal value appears on the display. Example:

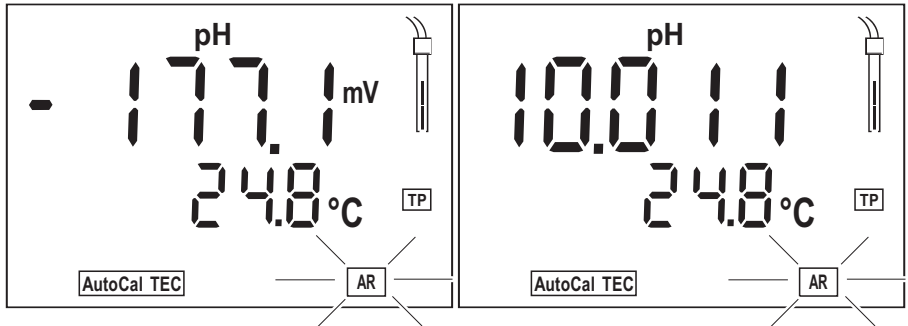

15 | When the measured value is stable, AR disappears. The value of the slope (mV/pH) appears on the display. The probe symbol shows the evaluation of the current calibration (three-point calibration).

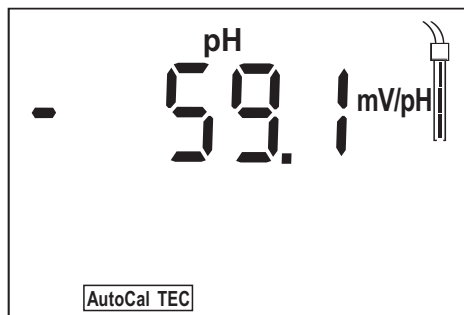

- 16 Press the **<RUN/ENTER>** key. The value of the asymmetry (mV) appears on the display.

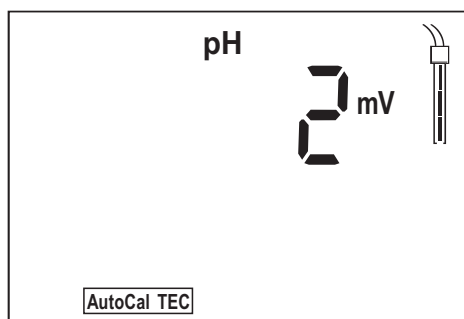

- 17 Switch to the measuring mode with **<M>**. The three-point calibration is complete.

4.3.2 AutoCal DIN

For this procedure, use two or three different standard buffer solutions according to DIN 19266 in ascending or descending order (type A, C, D or F with pH values at 25 °C of: 1.679 / 4.006 / 6.865 / 9.180).



Note

The buffer solutions are automatically recognized by the measuring instrument. Depending on the instrument setting (see section 4.4 CONFIGURATION), the instrument displays the relevant buffer nominal value or the current electrode voltage in mV.

- 1 Press the **<CAL>** key repeatedly until the display *Cd1* and the function display *AutoCal DIN* appear. The sensor symbol displays the evaluation of the last calibration (or no sensor symbol in the delivery state or after the measurement parameter has been reset).

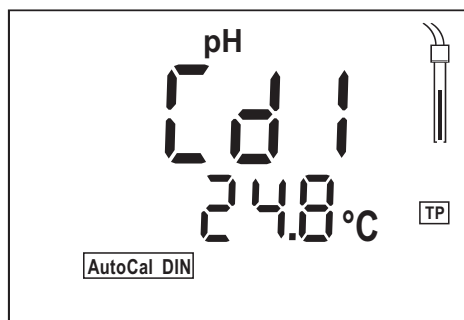

- 2 Immerse the pH electrode in the first buffer solution.
- 3 Press the **<RUN/ENTER>** key. The *AR* display indicator flashes. The electrode voltage (mV) or the buffer nominal value appears on the display. Example:

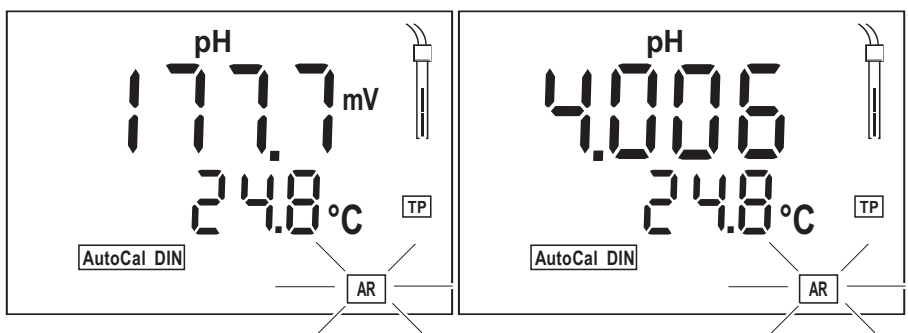

- 4 When the measured value is stable, *Ct2* appears.

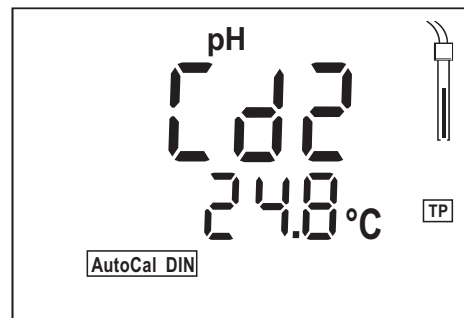
**Note**

At this point, the AutoCal TEC calibration can be terminated with **<M>**. This corresponds to a **single-point calibration**. To do this, the instrument uses the standard slope (-59.2 mV/pH at 25 °C) and determines the asymmetry of the electrode.

5	Thoroughly rinse the electrode with deionized water.
6	Immerse the pH electrode in the second buffer solution.
7	Press the <RUN/ENTER> key. The AR display indicator flashes. The electrode voltage (mV) or the buffer nominal value appears on the display. Example:

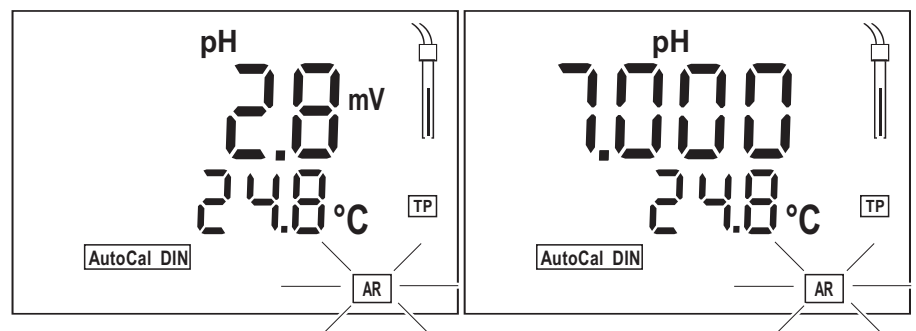

8	When the measured value is stable, AR disappears. The value of the slope (mV/pH) appears on the display. The probe symbol shows the evaluation of the current calibration (two-point calibration).
---	---

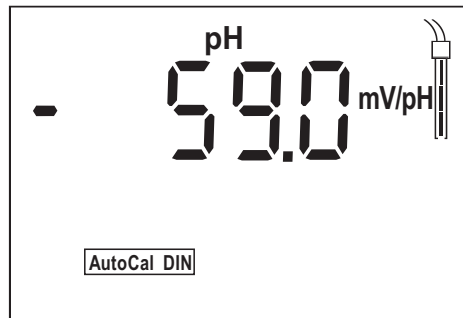

9 Press the **<RUN/ENTER>** key. The value of the asymmetry (mV) appears on the display.

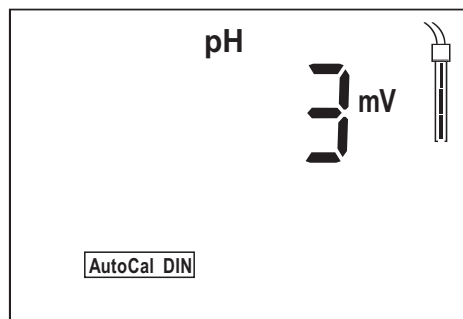

10 Change to the measuring mode with **<M>**, or proceed to the three-point calibration with **<RUN/ENTER>**.

Three-point calibration

- 11 Press the **<RUN/ENTER>** key. *Ct3* appears on the display.

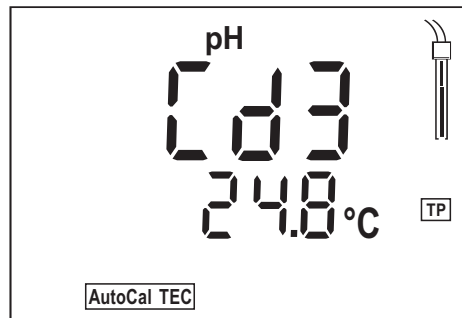

- 12 Thoroughly rinse the electrode with distilled water.
- 13 Immerse the pH electrode in the third buffer solution.
- 14 Press the **<RUN/ENTER>** key.
The *AR* display indicator flashes.
The electrode voltage (mV) or the buffer nominal value appears on the display. Example:

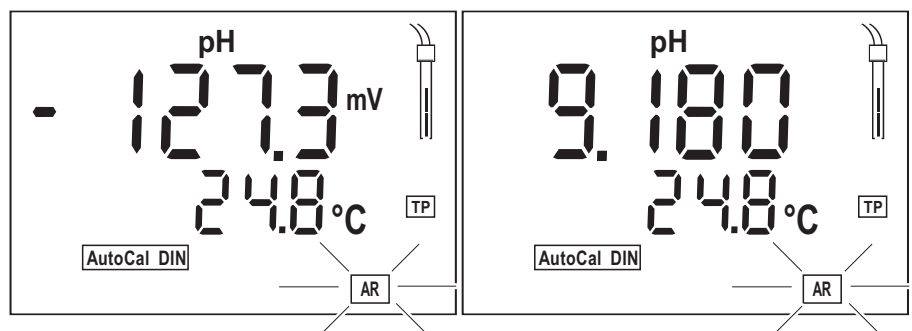

- 15 When the measured value is stable, *AR* disappears. The value of the slope (mV/pH) appears on the display. The probe symbol shows the evaluation of the current calibration (three-point calibration).

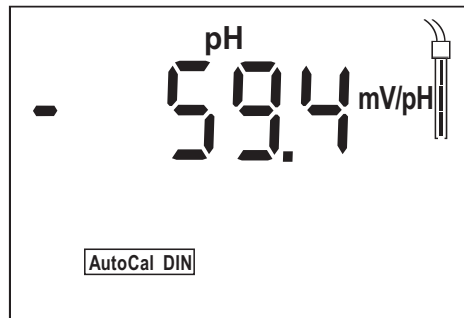

16 Press the **<RUN/ENTER>** key. The value of the asymmetry (mV) appears on the display.

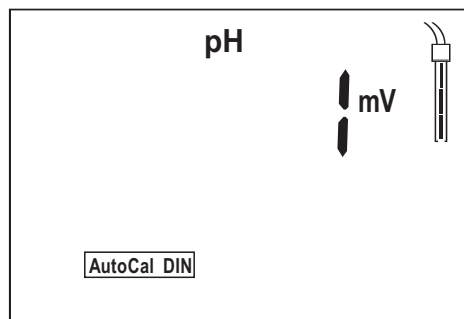

17 Switch to the measuring mode with **<M>**. The three-point calibration is complete.

4.4 Configuration

You can adapt the following setting to your individual requirements (the default setting is marked in bold):

Display during the
pH calibration

Buffer nominal value,
current electrode voltage

1	Switch off the measuring instrument.
2	Press the <M> key and hold it down.
3	Press the <ON/OFF> key. Display test appears briefly on the display. Afterwards, the measuring instrument switches automatically to the setting of the display during the pH calibration.

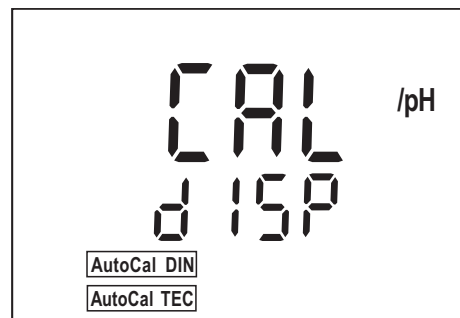

4	Select the required display during the pH calibration with <CAL> . <i>mV</i> : Display of the current electrode voltage <i>/pH</i> : Display of the buffer nominal value.
5	Confirm with <RUN/ENTER> . The measuring instrument automatically switches to the measuring mode.

Basic settings

4.5 Reset

The following settings are reset to the default values when a reset is performed (initialized):

Setting	Default settings
Measuring mode	pH
Asymmetry	0 mV
Slope	-59.16 mV/pH
Calibration procedure	AutoCal TEC
Resolution of pH display	0.01 (low resolution)

Proceed as follows:

- 1 Press the **<RUN/ENTER>** key and hold it down.
- 2 Press the **<CAL>** key.

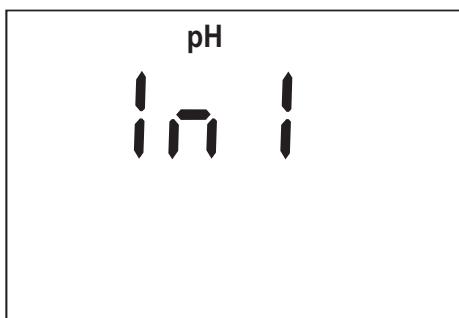

- 3 Confirm with **<RUN/ENTER>**. The settings are reset. The pH meter switches to the pH measuring mode.

Retaining settings:
Use **<M>** to change to the pH measuring mode without a reset.

5 Maintenance, cleaning, disposal

5.1 Maintenance

The measuring instrument is almost maintenance-free. The only maintenance task is replacing the batteries. *LoBat* indicates that the batteries should be changed. The batteries are then largely depleted.

Replacing the batteries

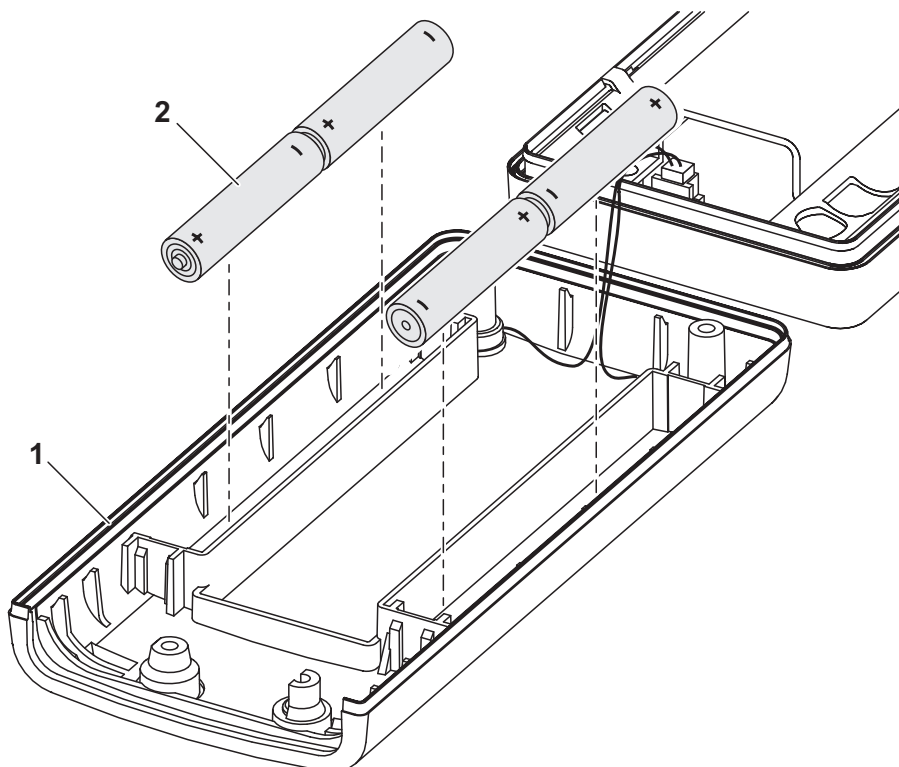

1	Open the housing after the instrument has been switched off: – Undo the four screws on the underside of the instrument – Pull down the lower cover (1).
2	If necessary, take the four depleted batteries (2) out of the battery compartment.
3	Place four new batteries (type Mignon AA) in the battery compartment.
4	Close the lower cover (1).



Warning

Make sure that the poles of the batteries are the right way round. The \pm signs on the batteries must correspond to the \pm signs in the battery compartment.
Only use leakproof alkaline manganese batteries.



Note

For the maintenance of the electrodes, follow the corresponding operating manual.

5.2 Cleaning

Occasionally wipe the outside of the measuring instrument with a damp, lint-free cloth. Disinfect the housing with isopropanol as required.



Warning

The housing is made of a synthetic material (ABS). Thus, avoid contact with acetone and similar detergents that contain solvents. Remove any splashes immediately.

5.3 Disposal

Packing

This measuring instrument is sent out in a protective transport packing. We recommend: Keep the packing material. The original packing protects the instrument against damage during transport.

Batteries

This note refers to the battery regulation that applies in the Federal Republic of Germany. We would ask end-consumers in other countries to follow their local statutory provisions.



Note

This instrument contains batteries. Batteries that have been removed must only be disposed of at the recycling facility set up for this purpose or via the retail outlet.

It is illegal to dispose of them in household refuse.

Measuring instrument

Dispose of the measuring instrument as electronic waste at an appropriate collection point. It is illegal to dispose of the instrument in household refuse.

6 What to do if...

Error message OFL

Cause	Remedy
pH electrode:	
– Not connected	– Connect electrode
– Air bubble in front of the diaphragm	– Remove air bubble
– Air in the diaphragm	– Extract air or moisten diaphragm
– Cable broken	– Replace electrode
– Gel electrolyte dried out	– Replace electrode

Error message E3

Cause	Remedy
Electrode	
– Diaphragm contaminated	– Clean diaphragm
– Membrane contaminated	– Clean membrane
– Moisture in the plug	– Dry plug
– Electrolyte out of date	– Replenish electrolyte or replace electrode
– Electrode worn out	– Replace electrode
– Electrode broken	– Replace electrode
Measuring instrument:	
– Incorrect calibration procedure	– Select correct procedure
– Incorrect solution temperature (without temperature probe)	– Set up correct temperature
– Socket damp	– Dry socket

Buffer solutions	
– Incorrect buffer solutions	– Change calibration procedure
– Buffer solutions too old	– Use only once. Note the shelf life
– Buffer solutions depleted	– Change solutions

No stable measured value

Cause	Remedy
pH electrode:	
– Diaphragm contaminated	– Clean diaphragm
– Membrane contaminated	– Clean membrane
Test sample:	
– pH value not stable	– Measure with air excluded if necessary
– Temperature not stable	– Adjust temperature if necessary
Electrode + test sample:	
– Conductivity too low	– Use suitable electrode
– Temperature too high	– Use suitable electrode
– Organic liquids	– Use suitable electrode

Display LoBat

Cause	Remedy
– Batteries almost empty	– Replace batteries (see section 5.1 MAINTENANCE)

Obviously incorrect measured values

Cause	Remedy
pH electrode:	
– pH electrode unsuitable	– Use suitable electrode
– Temperature difference between buffer and test sample too high	– Adjust temperature of buffers or sample
– Measurement procedure not suitable	– Follow special procedure

Instrument does not react to keystroke

Cause	Remedy
– Operating condition undefined or EMC load unallowed	– Press the <CAL> and <ON/OFF> keys at the same time and release them again. The software version is displayed briefly.

7 Technical data

Ambient temperature	Storage	- 25 °C ... + 65 °C
	Operation	-10 °C ... + 55 °C
	Allowable relative humidity	Yearly mean: < 75 % 30 days/year: 95 % Other days: 85 %

Measuring ranges and resolution of pH

	Measuring range	Resolution
pH	- 2.000 ... + 16.000 - 2.00 ... + 16.00	0.001 0.01
U [mV]	- 999.9 ... + 999.9 - 1999 ... + 1999	0.1 1
T [°C]	- 5.0 ... + 105.0	0.1

Accuracy (± 1 digit)

pH (± 2 pH units from the calibration point)	± 0.01
U [mV]	± 0.3 at + 15 °C ... + 35 °C ± 1
T [°C]	NTC 30: ± 0.1 PT 1000: ± 0.5 at 0 °C ... 15 °C ± 0.1 at 15 °C ... 35 °C ± 1 at 35 °C ... 55 °C

Dimensions and weight

Length [mm]	172
Width [mm]	80
Height [mm]	37
Weight [kg]	Approx. 0.3

Power supply	Batteries	4 x 1.5 V alkali-manganese batteries, Type AA
	Operational life	Approx. 3000 operating hours
Mechanical structure	Type of protection	IP 66
Guidelines and norms used	EMC	EG guideline 89/336/EEG EN 61326 -1:1997 EN 61000-3-2 A14:2000 EN 61000-3-3:1995; FCC Class A
	Instrument safety	EG guideline 73/23/EEG EN 61010-1 A2:1995
	Climatic class	VDI/VDE 3540
	Type of protection	EN 60529:1991

FCC Class A Equipment Statement

Note: This equipment has been tested and found to comply with the limits for a Class A digital device, pursuant to Part 15 of the FCC Rules. These limits are designed to provide reasonable protection against harmful interference when the equipment is operated in a commercial environment. This equipment generates, uses, and can radiate radio frequency energy and, if not installed and used in accordance with the instruction manual, may cause harmful interference to radio communications. Operation of this equipment in a residential area is likely to cause harmful interference in which case the user will be required to correct the interference at his own expense.

Test certificates cETLus, CE

8 Lists

This chapter provides additional information and orientation aids.

Abbreviations

The list of abbreviations explains the indicators and the abbreviations that appear on the display and in the manual.

Specialist terms

The glossary briefly explains the meaning of the specialist terms. However, terms that should already be familiar to the target group are not described here.

Index

The index will help you to find the topics that you are looking for.

Abbreviations

AR	AutoRead (drift control)
ARng	Automatic range switching Measuring instrument measures with highest resolution
ASY	Asymmetry
AutoCal DIN	Automatic pH calibration with buffer solutions prepared according to DIN 19 266
AutoCal TEC	Automatic pH calibration with WTW technical buffer solutions according to DIN 19267
°C	Temperature unit, degrees Celsius
Cal	Calibration
Cd...	Display indicator during calibration for pH measurements. Indicates the selection of the buffer data record for buffer solutions prepared according to DIN 19 266
Ct...	Display indicator during calibration for pH measurements. Indicates the selection of the buffer data records for WTW technical buffer solutions
E3	Error message see chapter 6 WHAT TO DO IF...
LoBat	Batteries almost empty (Low Battery)
mV	Voltage unit
mV/pH	Unit of the electrode slope (internat. mV)
OFL	Display range exceeded (Overflow)
pH	pH value
SELV	Safety Extra Low Voltage
TP	Temperature measurement active (Temperature Probe)
U _{ASY}	Asymmetry

Glossary

Adjusting	To manipulate a measuring system so that the relevant value (e. g. the displayed value) differs as little as possible from the correct value or a value that is regarded as correct, or that the difference remains within the tolerance.
Asymmetry	Designation for the offset potential of a pH electrode. It is the measurable potential of a symmetrical electrode, the membrane of which is immersed in a solution with the pH of the nominal electrode zero point (WTW electrodes: pH = 7).
AutoRange	Name of the automatic selection of the measuring range.
AutoRead	WTW name for a function to check the stability of the measured value.
Calibration	Comparing the value from a measuring system (e. g. the displayed value) to the correct value or a value that is regarded as correct. Often, this expression is also used when the measuring system is adjusted at the same time (see adjusting).
Diaphragm	The junction is a porous body in the housing wall of reference electrodes or electrolyte bridges. It forms the electrical contact between two solutions and makes electrolyte exchange more difficult. The expression, junction, is also used for ground or junction-less transitions.
Electrode voltage	The electromotive force U of the electrode is the measurable electromotive force of an electrode in a solution. It equals the sum of all the galvanic voltages of the electrode. Its dependency on the pH results in the electrode function which is characterized by the parameters, slope and zero point.
Electrode zero point	The zero point of a pH electrode is the pH value at which the electromotive force of the pH electrode at a specified temperature is zero. Normally, this is at 25 °C.
Measured parameter	The measured parameter is the physical dimension determined by measuring, e. g. pH, conductivity or D. O. concentration.
Measured value	The measured value is the special value of a measured parameter to be determined. It is given as a combination of the numerical value and unit (e. g. 3 m; 0.5 s; 5.2 A; 373.15 K).
Measuring system	The measuring system comprises all the devices used for measuring, e. g. measuring instrument and probe. In addition, there is the cable and possibly an amplifier, terminal strip and armature.
Molality	Molality is the quantity (in Mol) of a dissolved substance in 1000 g solvent.
MultiCal®	WTW name stating that a measuring instrument provides several calibration procedures.

Offset potential	The measurable potential of a symmetrical electrode, the membrane of which is immersed in a solution with the pH of the nominal electrode zero point. The asymmetry is part of the offset potential.
ORP voltage	The ORP is caused by oxidizing or reducing substances dissolved in water if these substances become effective on an electrode surface (e. g. a gold or platinum surface).
pH value	The pH is a measure of the acidic or basic effect of an aqueous solution. It corresponds to the negative decadic logarithm of the molal hydrogen ions activity divided by the unit of the molality. The practical pH value is the value of a pH measurement.
Reference temperature	Fixed temperature value to compare temperature-dependent measured values. For conductivity measurements, the measured value is converted to a conductivity value at a reference temperature of 20 °C or 25 °C.
Reset	Restoring the original condition of all settings of a measuring system.
Resolution	Smallest difference between two measured values that can be displayed by a measuring instrument.
Sample	Designation of the sample ready to be measured. Normally, a test sample is made by processing the original sample. The test sample and original sample are identical if the test sample was not processed.
Slope	The slope of a linear calibration function.

Index**A**

Asymmetry 17
Authorized use 9
AutoCal DIN 17, 24
AutoCal TEC 17, 19
AutoRead 15

B

Basic settings 30

C

Calibrating 17
Calibration evaluation 18
Calibration procedures 17
Changing the pH resolution
15

D

Default settings 30
Display 8
Displaying calibration data
17
Drift control 15

E

Error messages 33

I

Initialization 30

J

Jack field 8

K

Keys 7

L

LoBat 34

O

Operating safety 10
ORP electrode 16
ORP voltage 16

R

Replacing the batteries 31
Reset 30
Resetting parameters 30

S

Safety 9
safety precautions 9
Scope of delivery 11
Single-point calibration (pH)
17, 20, 25
Slope 17
software 35

T

Temperature sensor 14
Three-point calibration
AutoCal TEC 22, 27
Two-point calibration (pH)
17, 20, 25

